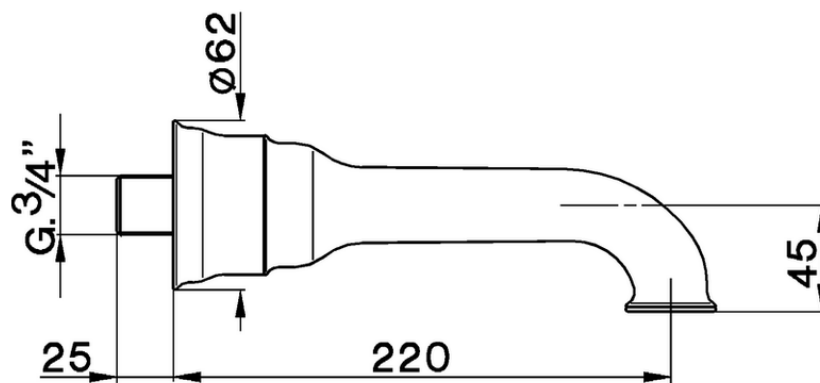

Bocca di erogazione ARCANA COMPLEMENTI_AR000242

AR000242

<https://www.cisal.it/bocca-di-erogazione-arcana-complementi-ar000242>

2026-06-17