

## Parte esterna termo doccia incasso 3 funzioni WELLNESS\_WE01R300

MODELLO **WE01R300**

Parte esterna termo doccia incasso 3 funzioni, per art.ZA01R300

### FINITURE DISPONIBILI

-  **21** 21 Cromo
-  **2F** 2F Nichel Spazzolato
-  **2Q** 2Q Black Titanium

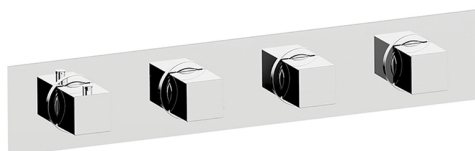

### CARATTERISTICHE

Installazione **Incasso**  
Parti Incasso necessarie **ZA01R300**

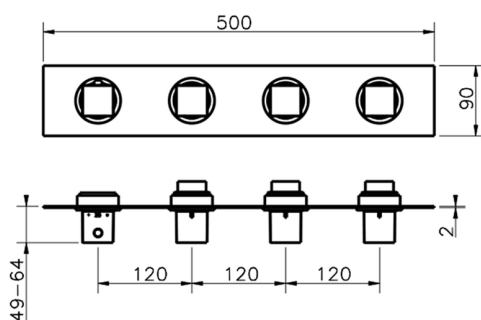

### Termostatico

Il Termostatico Cisal è il tuo personale gestore dell'acqua che ti aiuta a gestire e controllare acqua ed energia senza sprechi.



## Parte incasso termostatico 3 funzioni INCASSO\_ZA01R300

MODELLO **ZA01R300**

Parte incasso termostatico 3 funzioni

FINITURE DISPONIBILI



**04** 04 Senza Finitura

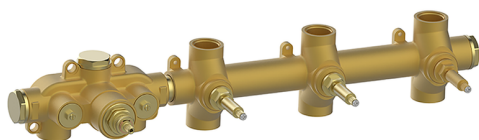

CARATTERISTICHE

Ricambio Cartuccia **23.51A.HF**

Incasso **1**

**Cartuccia Termostatica HF**

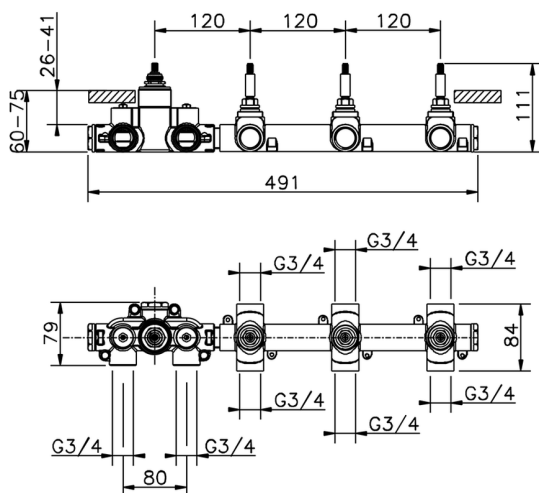

### Termostatico

Il Termostatico Cisal è il tuo personale gestore dell'acqua che ti aiuta a gestire e controllare acqua ed energia senza sprechi.



2026-05-02