

Parte esterna monocomando lavabo a pavimento HI-RISE_RI014514

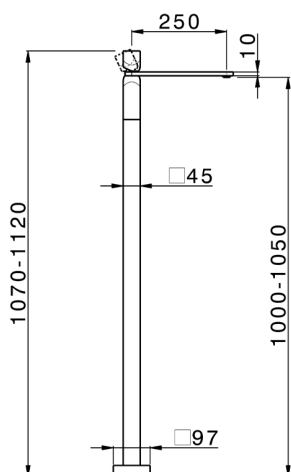
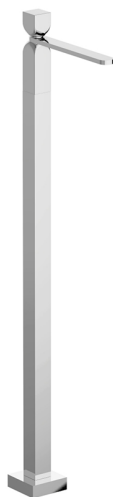

MODELLO **RI014514**

Parte esterna monocomando lavabo a pavimento, senza parte incasso, per art. ZA004510

FINITURE DISPONIBILI

-  **21** 21 Cromo
-  **24** 24 Oro
-  **2F** 2F Nichel Spazzolato
-  **2W** 2W Oro Spazzolato
-  **40** 40 Nero Opaco
-  **4Q** 4Q Bianco Opaco
-  **5G** 5G Oro Rosa
-  **6V** 6V Bianco Opaco/Nichel Spazzolato
-  **6X** 6X Bianco Opaco/Oro Spazzolato
-  **7W** 7W Nero Opaco/Oro Spazzolato

CARATTERISTICHE

Ricambio Cartuccia **ZZ96550000**
Cartuccia Monocomando 25 mm
 Installazione **Incasso**
 Parti Incasso necessarie **ZA004510**



Parte incasso monocomando free-standing INCASSO_ZA004510

MODELLO **ZA004510**

Parte incasso monocomando free-standing

FINITURE DISPONIBILI

 **04** 04 Senza Finitura

CARATTERISTICHE

Incasso **1**

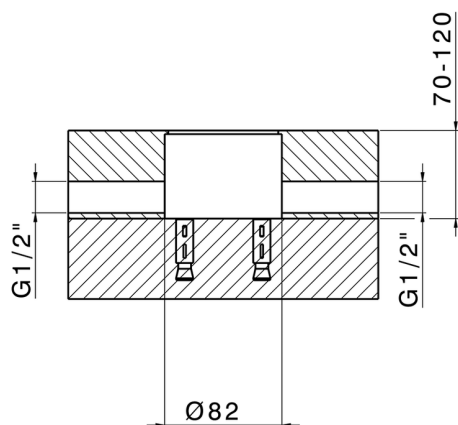

2026-05-04