

## Parte esterna termo doccia incasso 3 funzioni GRACE\_MN00R300

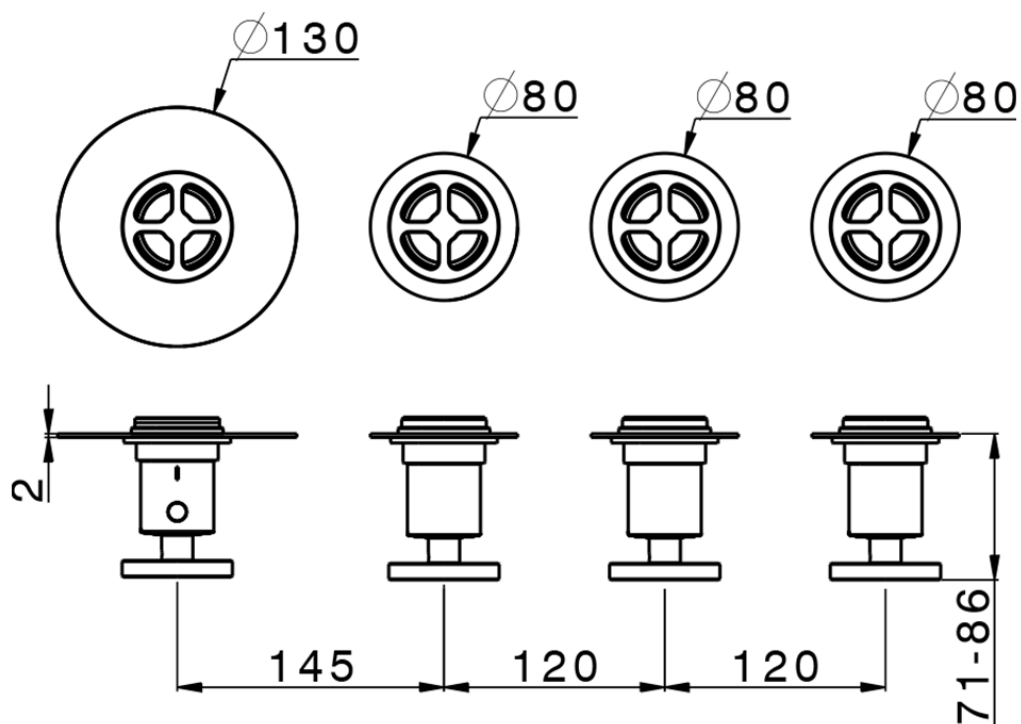

MN00R300

<https://www.cisal.it/parte-esterna-termo-doccia-incasso-3-funzioni-grace-mn00r300>



ZA00V300

<https://www.cisal.it/parte-incasso-termostatico-3-funzioni-incasso-za00v300>



ZA00R300

<https://www.cisal.it/parte-incasso-termostatico-3-funzioni-incasso-za00r300>

2026-05-02