

## Parte esterna termo doccia incasso 3 funzioni GRACE\_MN00R300

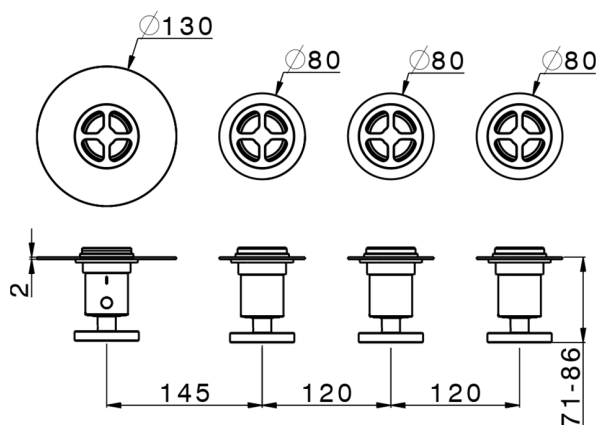

MODELLO **MN00R300**

Parte esterna termo doccia incasso 3 funzioni, per art.ZA00R300 installazione orizzontale, per art.ZA00V300 installazione verticale

### FINITURE DISPONIBILI

-  **21** 21 Cromo
-  **2F** 2F Nichel Spazzolato
-  **2W** 2W Oro Spazzolato
-  **5H** 5H Dark Brass Brushed
-  **5L** 5L Black Titanium Spazzolato
-  **6T** 6T Cromo/Nero Opaco

### CARATTERISTICHE

Installazione **Incasso**  
 Parti Incasso necessarie **ZA00V300**  
**ZA00R300**



### Termostatico

Il Termostatico Cisal è il tuo personale gestore dell'acqua che ti aiuta a gestire e controllare acqua ed energia senza sprechi.



## Parte incasso termostatico 3 funzioni INCASSO\_ZA00V300

MODELLO **ZA00V300**

Parte incasso termostatico 3 funzioni

FINITURE DISPONIBILI



CARATTERISTICHE

Ricambio Cartuccia **23.51A.HF**

Incasso **1**

**Cartuccia Termostatica HF**

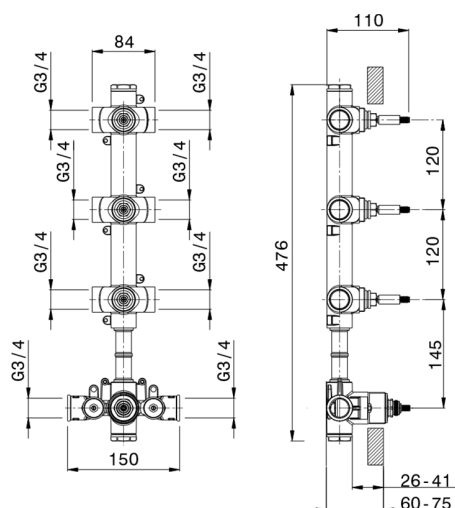

### Termostatico

Il Termostatico Cisal è il tuo personale gestore dell'acqua che ti aiuta a gestire e controllare acqua ed energia senza sprechi.



## Parte incasso termostatico 3 funzioni INCASSO\_ZA00R300

MODELLO **ZA00R300**

Parte incasso termostatico 3 funzioni

FINITURE DISPONIBILI



**04** 04 Senza Finitura

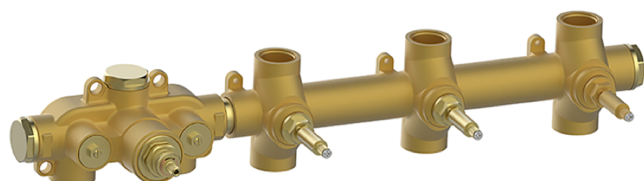

CARATTERISTICHE

Ricambio Cartuccia **23.51A.HF**

Incasso **1**

**Cartuccia Termostatica HF**

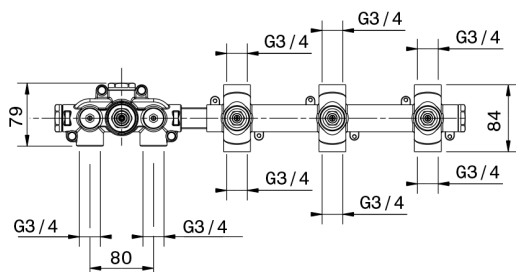
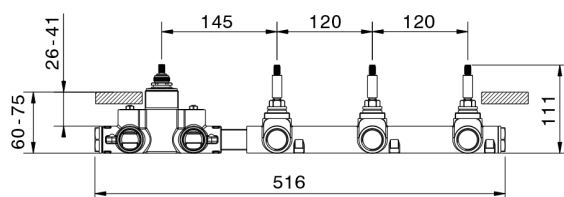

### Termostatico

Il Termostatico Cisal è il tuo personale gestore dell'acqua che ti aiuta a gestire e controllare acqua ed energia senza sprechi.



2026-06-19