

Bocca di erogazione CHERIE_CE000240

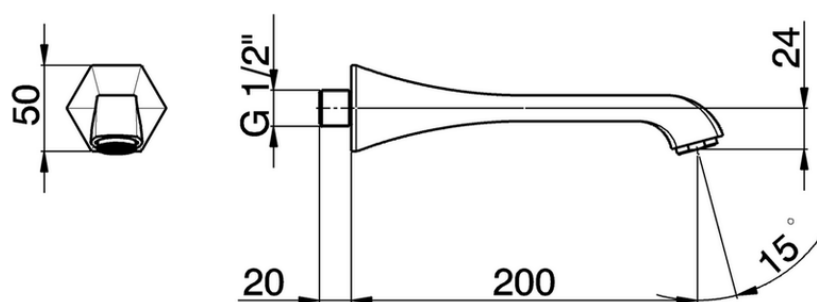

CE000240

<https://www.cisal.it/bocca-di-erogazione-cherie-ce000240>

2026-05-03