

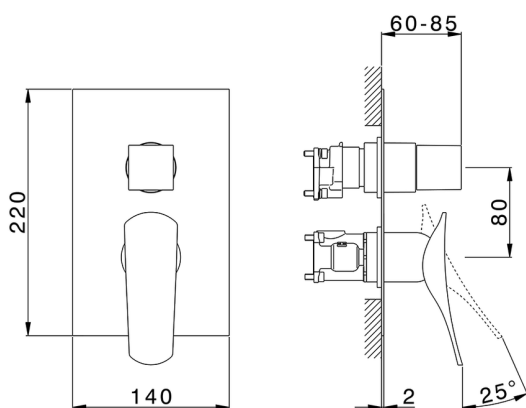

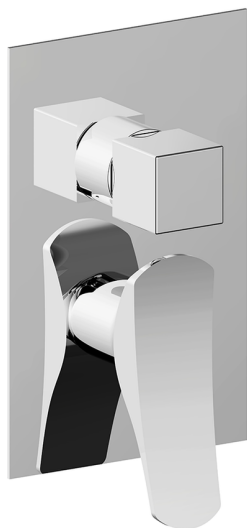



## Completo Monocomando per One-Box ROADSTER ACCENT\_RA0BM030



MODELLO **RA0BM030**

Completo Monocomando per One-Box, con deviatore 2-3 uscite, profondità minima di installazione 67 mm, senza parte incasso, per art. ZA00B030-ZA00B031

### FINITURE DISPONIBILI

-  **21** 21 Cromo
-  **2B** 2B Nichel Lucido
-  **2F** 2F Nichel Spazzolato
-  **2Q** 2Q Black Titanium
-  **40** 40 Nero Opaco
-  **4Q** 4Q Bianco Opaco

### CARATTERISTICHE

Ricambio Cartuccia **ZZ97179000**

**Cartuccia Monocomando 35 mm**

Installazione **Incasso**

Parti Incasso necessarie **ZA00B031**

**ZA00B030**



## Completo Monocomando per One-Box ROADSTER ACCENT\_RA0BM030

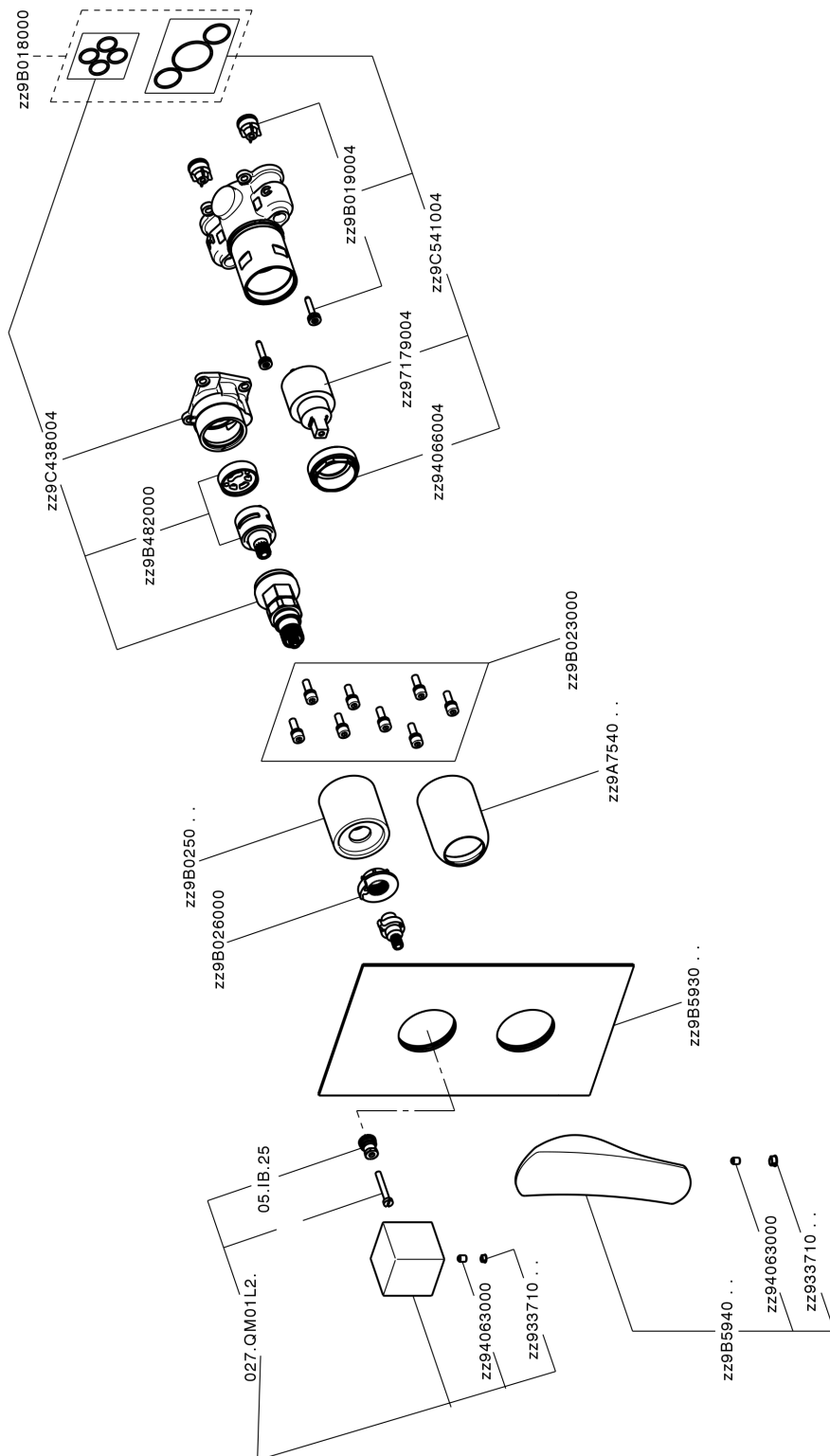

RA0BM030

<https://www.cisal.it/completo-monocomando-per-one-box-roadster-accent-ra0bm030>

## One-Box Universale per incasso ONE BOX\_ZA00B031

MODELLO **ZA00B031**

One-Box Universale per incasso, per termostatico o monocomando 1, 2 o 3 uscite, senza parte esterna, con silenziosi, con guarnizione per sigillatura

FINITURE DISPONIBILI

 **04** 04 Senza Finitura

CARATTERISTICHE

Incasso **1**



### Termostatico

Il Termostatico Cisal è il tuo personale gestore dell'acqua che ti aiuta a gestire e controllare acqua ed energia senza sprechi.



## One-Box Universale per incasso ONE BOX\_ZA00B030

MODELLO **ZA00B030**

One-Box Universale per incasso, per termostatico o monocomando 1, 2 o 3 uscite, senza parte esterna, senza silenziosi, con guarnizione per sigillatura

FINITURE DISPONIBILI

 **04** 04 Senza Finitura

CARATTERISTICHE

Incasso **1**



### Termostatico

Il Termostatico Cisal è il tuo personale gestore dell'acqua che ti aiuta a gestire e controllare acqua ed energia senza sprechi.



2026-05-09