





Miscelatore monocomando lavabo EnergySave CUBIC_CU000545



MODELLO **CU000545**

Miscelatore monocomando lavabo EnergySave, senza scarico automatico, flex inox G.3/8"

FINITURE DISPONIBILI

-  **21** 21 Cromo
-  **2B** 2B Nichel Lucido
-  **2F** 2F Nichel Spazzolato
-  **40** 40 Nero Opaco

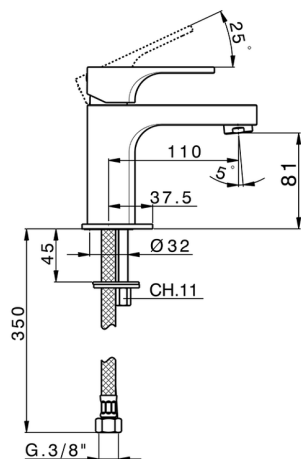

CARATTERISTICHE

Ricambio Cartuccia **ZZ96691000**

Cartuccia Monocomando 25 mm



EnergySave

Con il dispositivo EnergySave, all'apertura con leva in posizione centrale il miscelatore eroga unicamente acqua fredda, evitando così l'inutile accensione della caldaia e il conseguente spreco di acqua calda, con il beneficio di un notevole risparmio energetico ed economico. La regolazione della temperatura avviene ruotando la leva verso sinistra, fino alla temperatura massima desiderata.



Miscelatore monocomando lavabo EnergySave CUBIC_CU000545

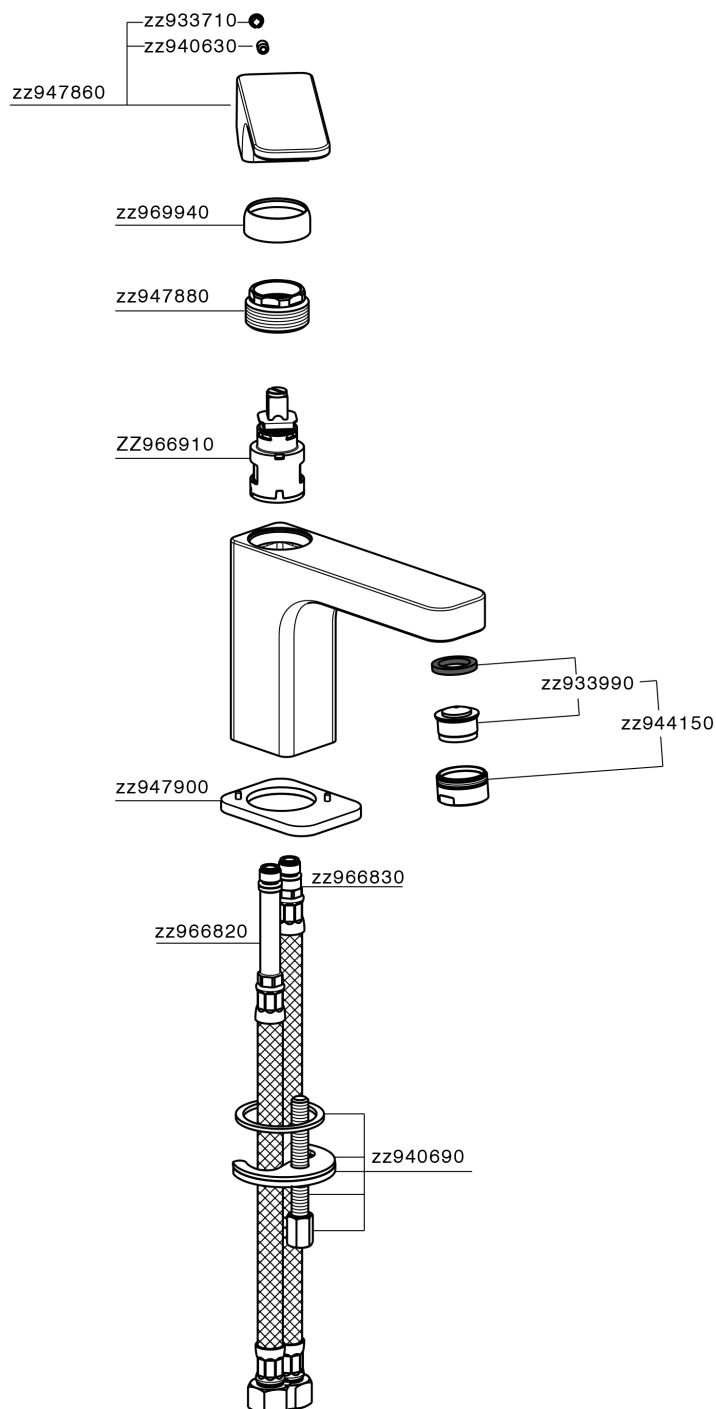

CU000545

<https://www.cisal.it/miscelatore-monocomando-lavabo-energysave-cubic-cu000545>

2026-05-08