

Parte esterna termostatico doccia incasso 1 uscita ARCANA EMPRESS_EM007280

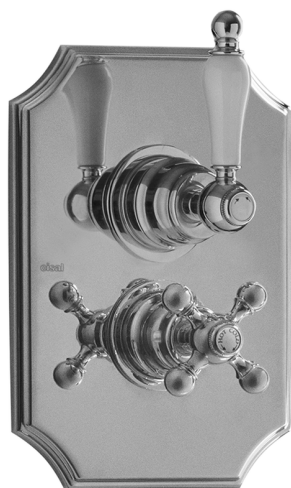

MODELLO **EM007280**

Parte esterna termostatico doccia incasso 1 uscita, rubinetto d'arresto, senza parte incasso, per art. ZA007281

FINITURE DISPONIBILI

-  **21** 21 Cromo
-  **24** 24 Oro
-  **26** 26 Vecchio Rame
-  **27** 27 Vecchio Bronzo
-  **2A** 2A Nichel Satinato Spazzolato

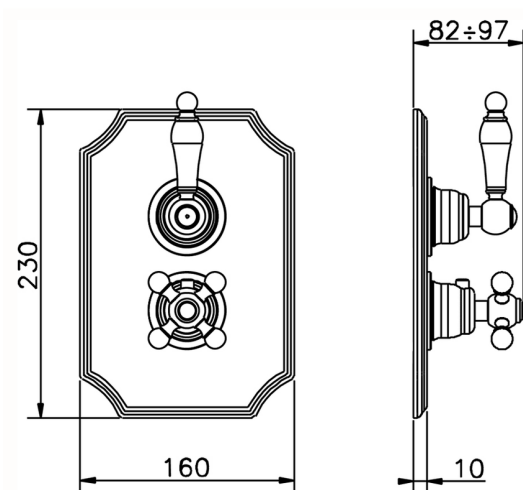

CARATTERISTICHE

Installazione **Incasso**
Parti Incasso necessarie **ZA007281**



Termostatico

Il Termostatico Cisal è il tuo personale gestore dell'acqua che ti aiuta a gestire e controllare acqua ed energia senza sprechi.



Parte incasso termostatico doccia 1 uscita INCASSO_ZA007281

MODELLO **ZA007281**

Parte incasso termostatico doccia 1 uscita, rubinetto d'arresto con uscita 1/2", senza parte esterna

FINITURE DISPONIBILI



04 04 Senza Finitura

CARATTERISTICHE

Ricambio Cartuccia **24.04A.PP**

Incasso **1**

Cartuccia Termostatica Plus P 8X20

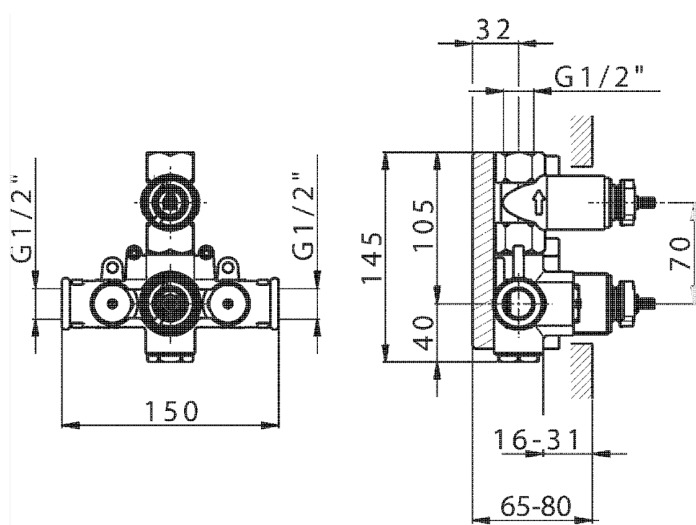

Termostatico

Il Termostatico Cisal è il tuo personale gestore dell'acqua che ti aiuta a gestire e controllare acqua ed energia senza sprechi.



2026-05-09