

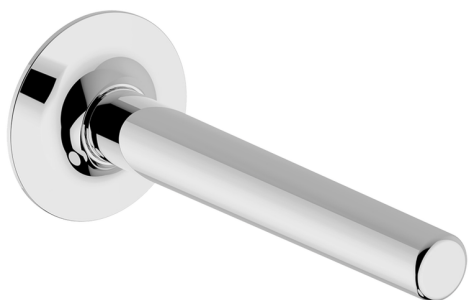



Bocca di erogazione VITA_VI000240

MODELLO **VI000240**

Bocca di erogazione, L.200 mm, attacco 1/2" M



FINITURE DISPONIBILI

-  **21** 21 Cromo
-  **2Q** 2Q Black Titanium
-  **40** 40 Nero Opaco
-  **4Q** 4Q Bianco Opaco

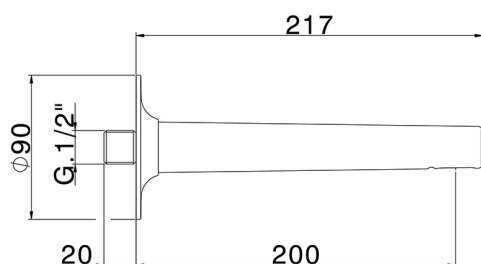

CARATTERISTICHE



Bocca di erogazione VITA_VI000240

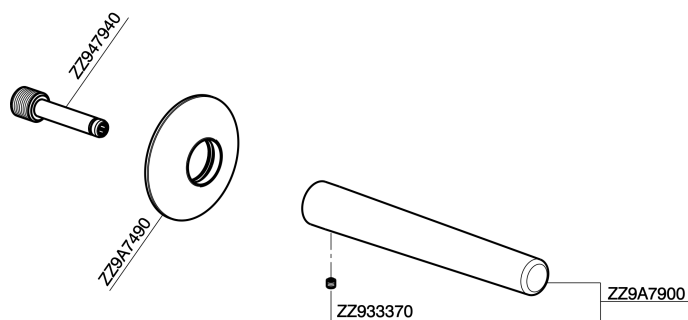

VI000240

<https://www.cisal.it/bocca-di-erogazione-vita-vi000240>

2026-05-25