

Parte esterna termostatico doccia incasso 1 uscita ROCK&ROLL_RK007300

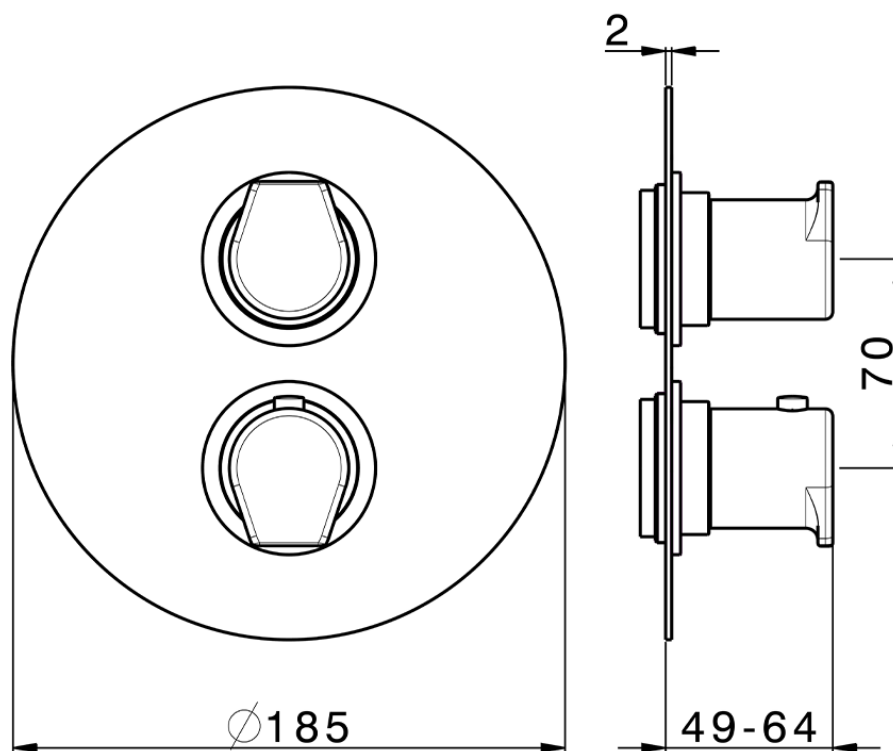

RK007300

<https://www.cisal.it/parte-esterna-termostatico-doccia-incasso-1-uscita-rockroll-rk007300>



Piastra/Plate/Plaque/Platte/Placa
 2-3mm: XX 25-40 YY 76-91
 10mm: XX 16-31 YY 65-80

ZA007301

<https://www.cisal.it/parte-incasso-termostatico-doccia-1-uscita-incasso-za007301>

2026-06-19