

Parte esterna termostatico doccia incasso 2 uscite ARCANA ROYAL_AY018100

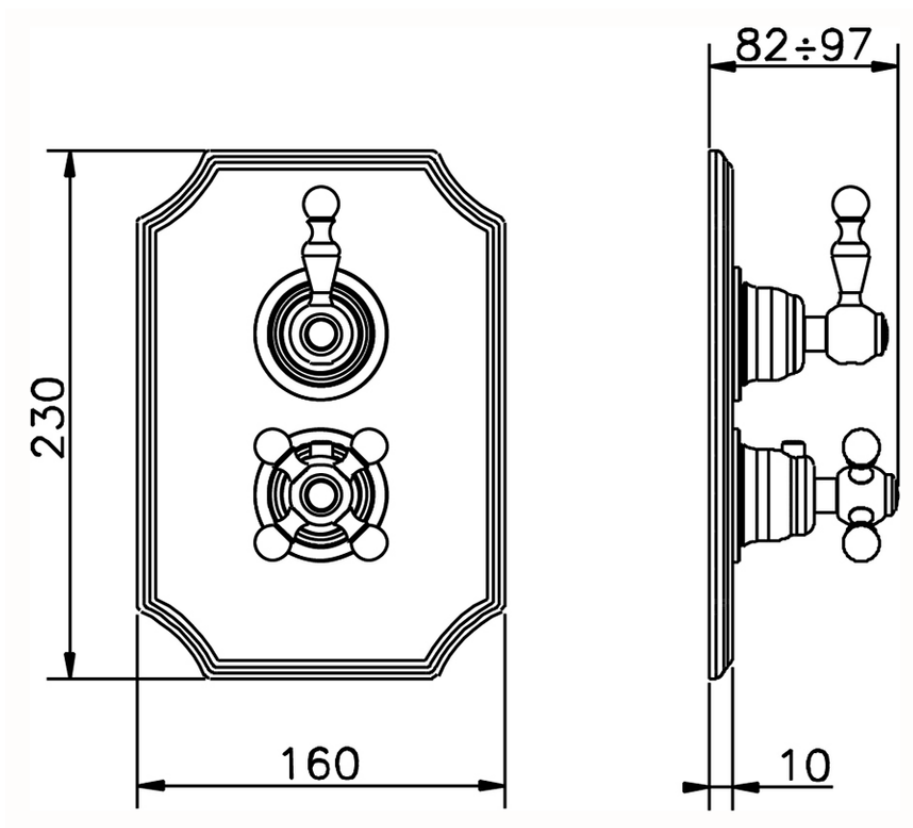

AY018100

<https://www.cisal.it/parte-esterna-termostatico-doccia-incasso-2-uscite-arcana-royal-ay018100>



Piastra/Plate/Plaque/Platte/Placa

2-3mm: XX 25-40 YY 76-91

10 mm: XX 16-31 YY 65-80

ZA018101

<https://www.cisal.it/parte-incasso-termostatico-doccia-2-uscite-incasso-za018101>

2026-07-09