

Parte esterna termostatico doccia incasso 1 uscita GRACE_GL007306

MODELLO **GL007306**

Parte esterna termostatico doccia incasso 1 uscita, rubinetto d'arresto, senza parte incasso, per art. ZA007306

FINITURE DISPONIBILI

-  **21** 21 Cromo
-  **2F** 2F Nichel Spazzolato
-  **2W** 2W Oro Spazzolato
-  **5H** 5H Dark Brass Brushed
-  **5L** 5L Black Titanium Spazzolato
-  **6T** 6T Cromo/Nero Opaco

CARATTERISTICHE

Installazione **Incasso**
Parti Incasso necessarie **ZA007306**

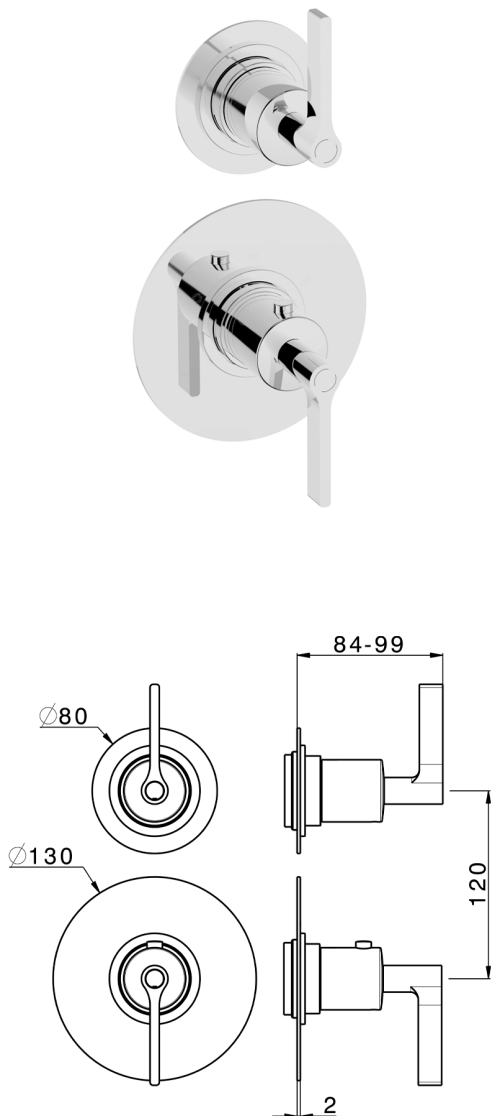

Termostatico

Il Termostatico Cisal è il tuo personale gestore dell'acqua che ti aiuta a gestire e controllare acqua ed energia senza sprechi.



2026-07-03