





Parte esterna termostatico doccia incasso 2 uscite LESS MINIMAL_LN018100

MODELLO **LN018100**

Parte esterna termostatico doccia incasso 2 uscite, con deviasstop 2 uscite, senza parte incasso, per art. ZA018101

FINITURE DISPONIBILI

-  **21** 21 Cromo
-  **2F** 2F Nichel Spazzolato
-  **40** 40 Nero Opaco
-  **4Q** 4Q Bianco Opaco

CARATTERISTICHE

Installazione **Incasso**
 Parti Incasso necessarie **ZA018101**

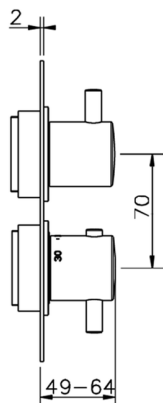
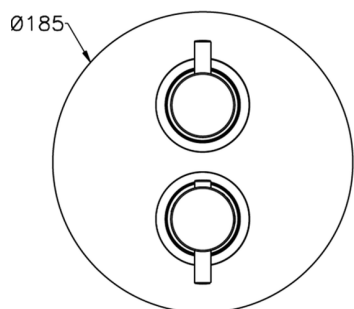

Termostatico

Il Termostatico Cisal è il tuo personale gestore dell'acqua che ti aiuta a gestire e controllare acqua ed energia senza sprechi.



Parte esterna termostatico doccia incasso 2 uscite LESS MINIMAL_LN018100

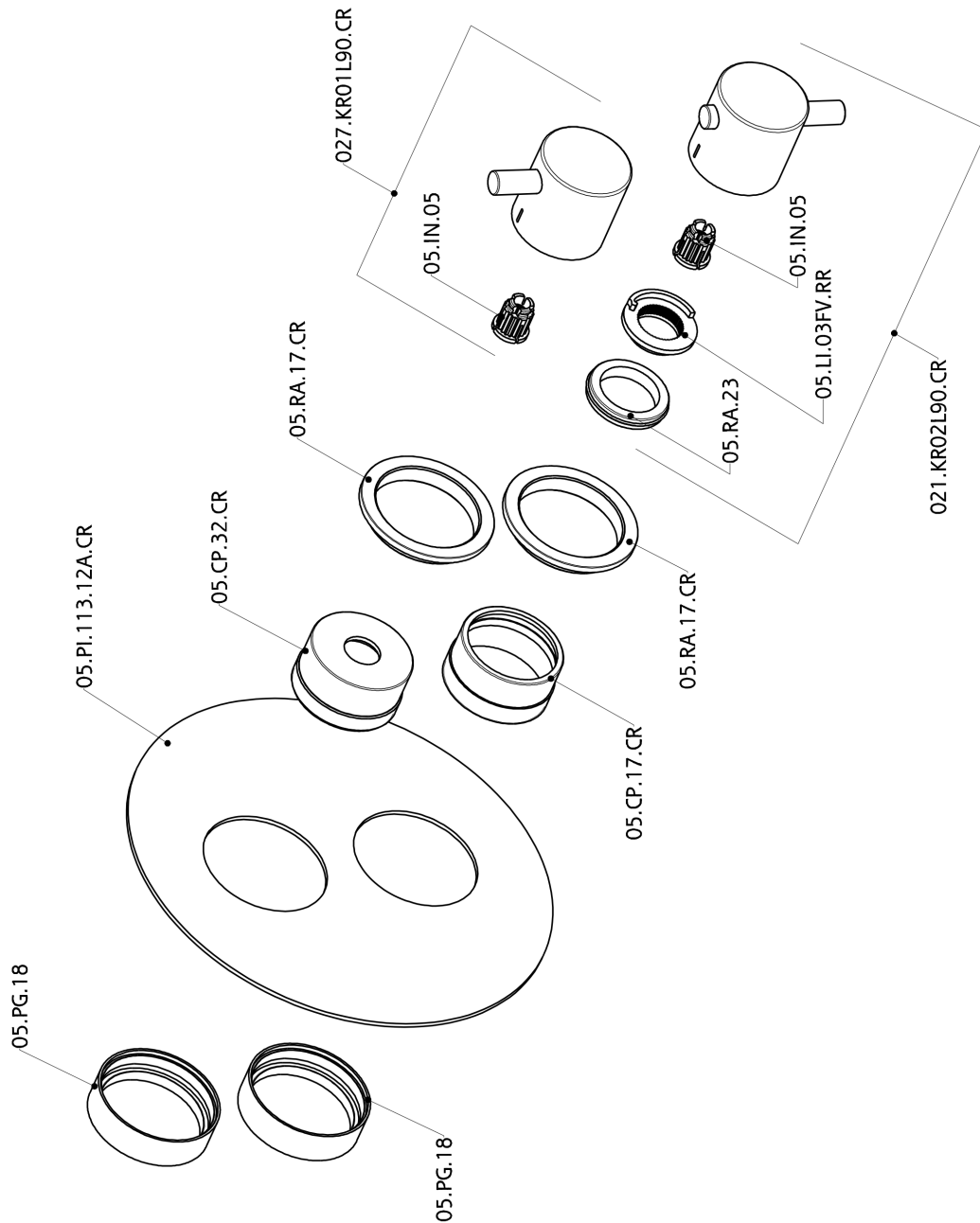

LN018100

<https://www.cisal.it/parte-esterna-termostatico-doccia-incasso-2-uscite-less-minimal-ln018100>

Parte incasso termostatico doccia 2 uscite INCASSO_ZA018101

MODELLO **ZA018101**

Parte incasso termostatico doccia 2 uscite, con devia stop 2 uscite 1/2", senza parte esterna



FINITURE DISPONIBILI



04 04 Senza Finitura

CARATTERISTICHE

Ricambio Cartuccia **24.04A.PP**

Incasso **1**

Cartuccia Termostatica Plus P 8X20



Piastra/Plate/Plaque/Platte/Placa

2-3mm: XX 25-40 YY 76-91

10 mm: XX 16-31 YY 65-80



DeviaStop

La tecnologia Devia Stop di Cisal consente con un semplice movimento rotativo di gestire la portata dell'acqua e di scegliere la modalità d'erogazione (soffione, doccia a mano).



Termostatico

Il Termostatico Cisal è il tuo personale gestore dell'acqua che ti aiuta a gestire e controllare acqua ed energia senza sprechi.



2026-06-20