

Parte esterna termostatico vasca incasso 2 uscite HI-RISE_RI019440

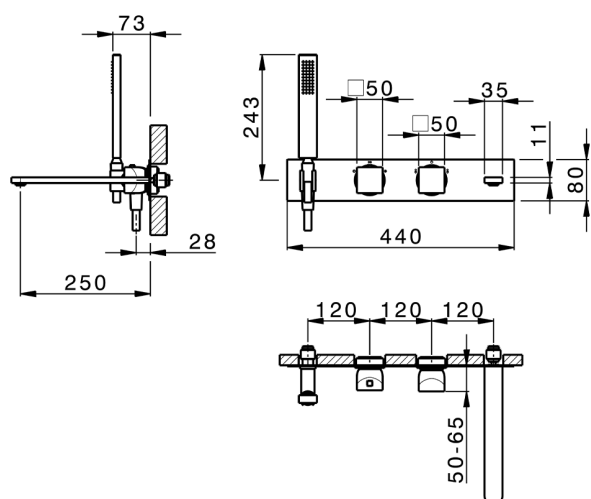
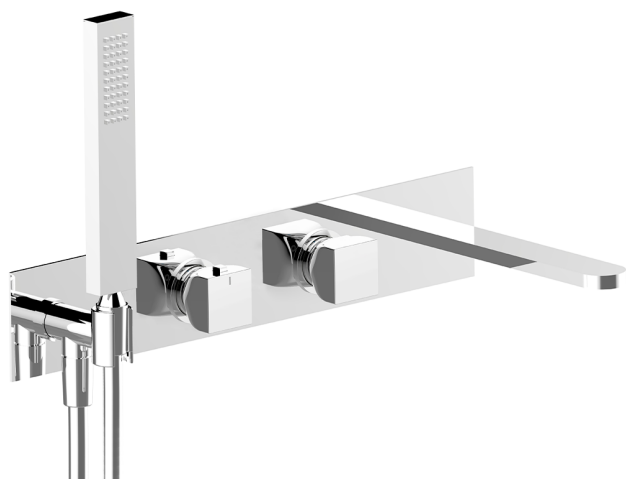

MODELLO **RI019440**

Parte esterna termostatico vasca incasso 2 uscite, con deviaspout 2 uscite, senza parte incasso, per art. ZA019440

FINITURE DISPONIBILI

-  **21** 21 Cromo
-  **24** 24 Oro
-  **2F** 2F Nichel Spazzolato
-  **2W** 2W Oro Spazzolato
-  **40** 40 Nero Opaco
-  **4Q** 4Q Bianco Opaco
-  **5G** 5G Oro Rosa
-  **6V** 6V Bianco Opaco/Nichel Spazzolato
-  **6X** 6X Bianco Opaco/Oro Spazzolato
-  **7W** 7W Nero Opaco/Oro Spazzolato



Termostatico

Il Termostatico Cisal è il tuo personale gestore dell'acqua che ti aiuta a gestire e controllare acqua ed energia senza sprechi.

CARATTERISTICHE

Installazione **Incasso**
Parti Incasso necessarie **ZA019440**



Parte incasso termostatico vasca 2 uscite INCASSO_ZA019440

MODELLO **ZA019440**

Parte incasso termostatico vasca 2 uscite, senza parte esterna

FINITURE DISPONIBILI

 **04** 04 Senza Finitura

CARATTERISTICHE

Ricambio Cartuccia **24.04A.PP**

Incasso **1**

Cartuccia Termostatica Plus P 8X20

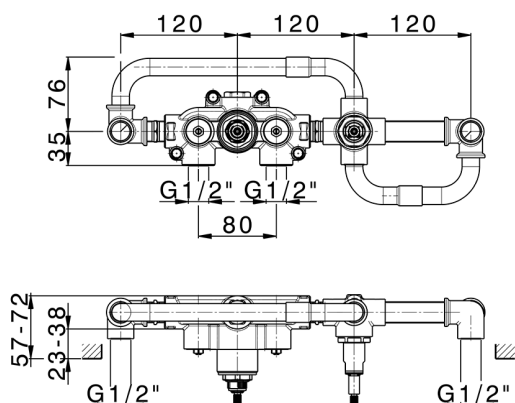

Termostatico

Il Termostatico Cisal è il tuo personale gestore dell'acqua che ti aiuta a gestire e controllare acqua ed energia senza sprechi.



2026-05-05