

Parte esterna termostatico incasso PUSH&SHOWER_PS1G1030

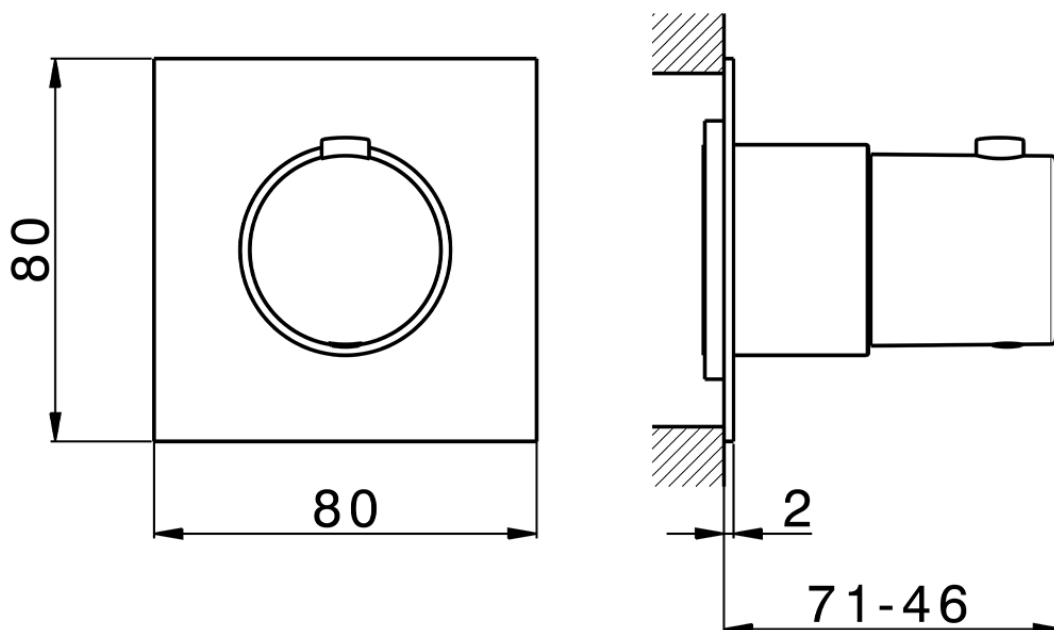

PS1G1030

<https://www.cisal.it/parte-esterna-termostatico-incasso-pushshower-ps1g1030>

2026-04-14