

Parte esterna termostatico doccia incasso 2 uscite HI-RISE_RI019100

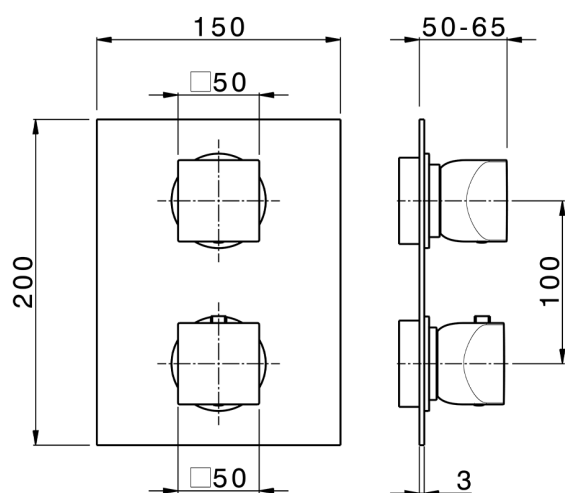

MODELLO **RI019100**

Parte esterna termostatico doccia incasso 2 uscite, con deviasstop 2 uscite, senza parte incasso, per art. ZA019101

FINITURE DISPONIBILI

-  **21** 21 Cromo
-  **24** 24 Oro
-  **2F** 2F Nichel Spazzolato
-  **2W** 2W Oro Spazzolato
-  **40** 40 Nero Opaco
-  **4Q** 4Q Bianco Opaco
-  **5G** 5G Oro Rosa
-  **6V** 6V Bianco Opaco/Nichel Spazzolato
-  **6X** 6X Bianco Opaco/Oro Spazzolato
-  **7W** 7W Nero Opaco/Oro Spazzolato



Termostatico

Il Termostatico Cisal è il tuo personale gestore dell'acqua che ti aiuta a gestire e controllare acqua ed energia senza sprechi.

CARATTERISTICHE

Installazione **Incasso**
 Parti Incasso necessarie **ZA019101**



Parte incasso termostatico doccia 2 uscite INCASSO_ZA019101

MODELLO **ZA019101**

Parte incasso termostatico doccia 2 uscite, con deviasp 2 uscite 1/2", senza parte esterna

FINITURE DISPONIBILI

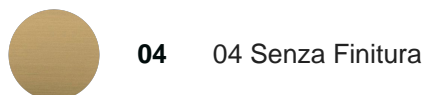

CARATTERISTICHE

Ricambio Cartuccia **24.04A.PP**

Incasso **1**

Cartuccia Termostatica Plus P 8X20

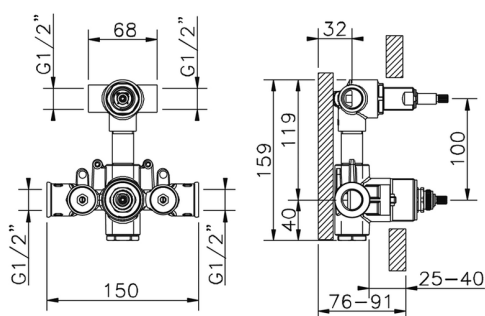

DeviaStop

La tecnologia Devia Stop di Cisal consente con un semplice movimento rotativo di gestire la portata dell'acqua e di scegliere la modalità d'erogazione (soffione, doccetta a mano).



Termostatico

Il Termostatico Cisal è il tuo personale gestore dell'acqua che ti aiuta a gestire e controllare acqua ed energia senza sprechi.



2026-06-29