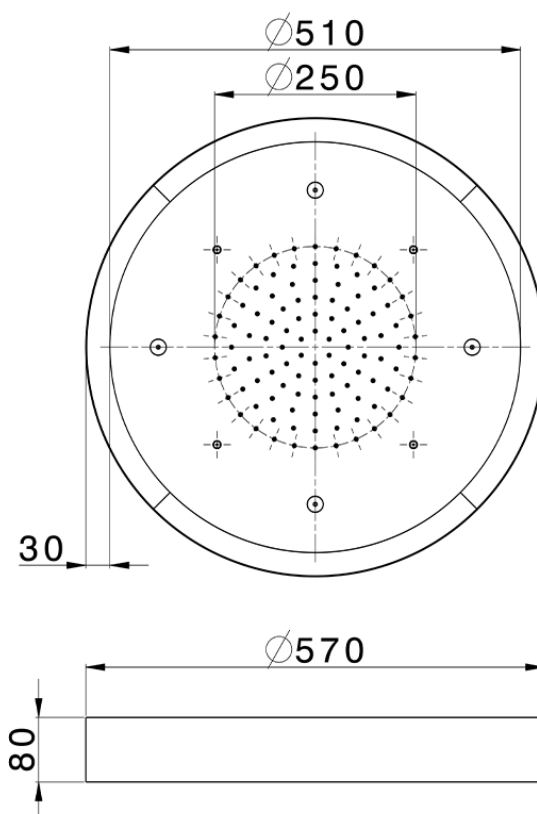

Soffione a soffitto con cromoterapia Ø 570 mm WELLNESS_ZS0C0175

ZS0C0175

<https://www.cisal.it/soffione-a-soffitto-con-cromoterapia-o-570-mm-wellness-zs0c0175>

2026-06-27