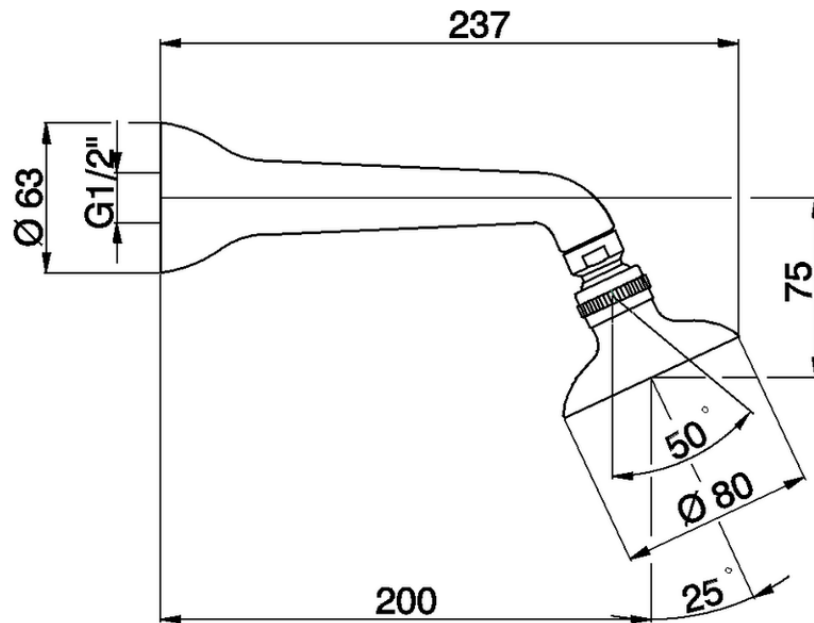

Braccio doccia ARCANA COMPLEMENTI_AR001540

AR001540

<https://www.cisal.it/braccio-doccia-arcana-complementi-ar001540>

2026-06-27