





## Miscelatore lavello KITCHEN\_RE000530

MODELLO **RE000530**

Miscelatore lavello, bocca girevole, flex inox G.3/8"



### FINITURE DISPONIBILI

-  **21** 21 Cromo
-  **26** 26 Vecchio Rame
-  **27** 27 Vecchio Bronzo
-  **49** 49 Terra di Francia

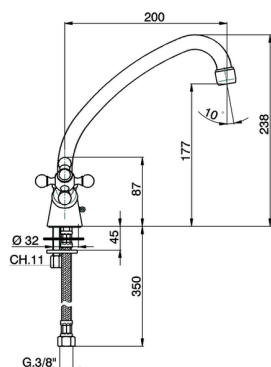

### CARATTERISTICHE



## Miscelatore lavello KITCHEN\_RE000530

# cisal

### RE 00052 (RE 00053)

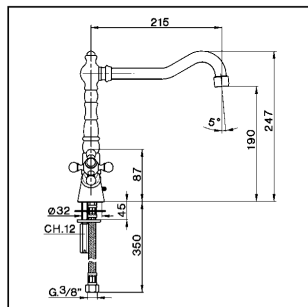

- Monoforo lavello
- Single hole sink mixer
- Einloch-Spültischbatterie
- Mélangeur monotrou évier

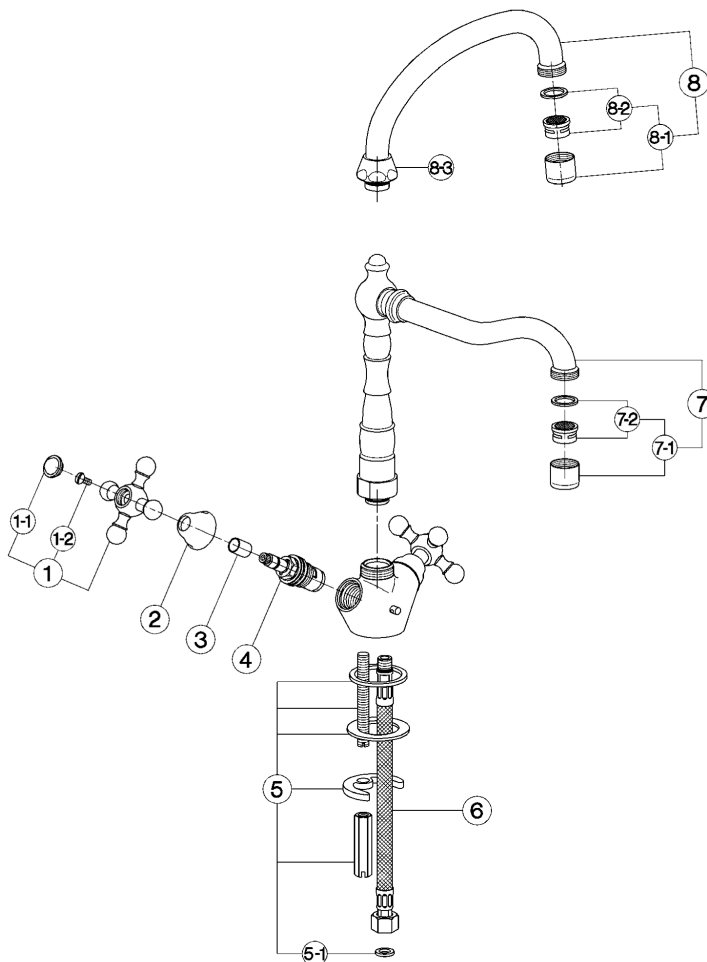

bar	PORTATA BOCCA DI EROGAZIONE * SPOUT FLOW RATE DURCHFLOSS WANNENEINLAUF DEBIT BEC DEVERSEUR l/min.
0.5	5.5
1	8
2	11
3	13.5
4	15.5
5	17.5

\* con resistenza silenziosa della classe di portata A (15 l/min. a 3 bar)  
with hydraulic resistance of flow rate class A (15 l/min. at 3 bar)  
mit geräuscharmen Widerstand der Durchflussklasse A (15 l/min. bei 3 bar)  
avec aérateur classe A (15 l/min. à 3 bar)

NR.	DESCRIZIONE DESCRIPTION BESCHREIBUNG DESCRIPTION	N. CODICE CODE NO. WERKSNR. NR. CODE	NR.	DESCRIZIONE DESCRIPTION BESCHREIBUNG DESCRIPTION	N. CODICE CODE NO. WERKSNR. NR. CODE	NR.	DESCRIZIONE DESCRIPTION BESCHREIBUNG DESCRIPTION	N. CODICE CODE NO. WERKSNR. NR. CODE
1	Maniglia "AR" con vite e piacchetta Handle with screw and plate "AR" Griff "AR" mit Schraube und Abdeckkappe Croisillon avec vis et plaquette "AR"	ZZ 90307 0	5	Set installazione monoforo Installation set single hole Befestigungsset Set installation	ZZ 92828 0	8	Canna alta Ø18 interasse 200 con aeratore Swinging spout 200 Ø18 with mousseur Auslauf-Rohr-U-200 Ø18 mit Perlator Bec orientable 200 Ø18 avec mousseur	ZZ 92801 0
1-1	Piacchetta a vite maniglia "AR" Cap for handle "AR" Abdeckkappe "AR" Griff Plaquette cache - vis crois. "AR"	ZZ 92617 0	5-1	Guarnizione fibra 3/8" Gasket rubber 3/8" Fiberdichtung 3/8" Joint en fibre 3/8"	ZZ 92696 0	8-1	Aeratore M.22x1 IB Mousseur M.22x1 IB Perlator M.22x1 IB Mousseur M.22x1 IB	ZZ 92841 0
1-2	Vite M.4,5x10 tb. tc. zigrinata Screw M.4,5x10 Schraube M.4,5x10 Vis M.4,5x10	ZZ 92609 0	6	Flessibile M.11x1 3/8" L.365 Flex M.11x1 3/8" L.365 Anschlussschlauch M.11x1 3/8" L.365 Flex M.11x1 3/8" L.365	ZZ 92842 0	8-2	Cartuccia per aeratore M. 22x1 Mousseur cartridge M.22x1 Kart. f/Perlator M.22x1 Cartouche x mousseur M.22x1	ZZ 92703 0
2	Cappuccio coprivite Ø32 H.21 "AC" Escaltheon Ø32 H.21 "AC" headvalve Abdeckkappe Ø32 H.21 "AC" Rosace couvre-tête Ø32 H.21 "AC"	ZZ 92652 0	7	Canna alta "RE" Spout "RE" Auslauf-Rohr-U-"RE" Bec "RE"	ZZ 90819 0	8-3	Calotta 3/4" es.29 Ø19,5 Nut 3/4" Ø19,5 Mutter 3/4" Ø19,5 Ecrou 3/4" Ø19,5	ZZ 92615 0
3	Tubetto copriasta "AR" H.15,5 Sliding cover tube "AR" H.15,5 Abdeckkappe Oberteil "AR" H.15,5 Tube couvre-tête "AR" H.15,5	ZZ 92619 0	7-1	Aeratore M.22x1 IB Mousseur M.22x1 IB Perlator M.22x1 IB Mousseur M.22x1 IB	ZZ 92841 0			
4	Vitone ceramico DX per monofori e gruppi "AC" Ceramic headvalve 1/2" right "AC" -short Keramikoberteil 1/2" rechts "AC" -kurz Tête céramique 1/2" droite "AC" - courte	ZZ 92858 0	7-2	Cartuccia per aeratore M. 22x1 Mousseur cartridge M.22x1 Kart. f/Perlator M.22x1 Cartouche x mousseur M.22x1	ZZ 92703 0			

AC.17

RE000530

<https://www.cisal.it/miscelatore-lavello-kitchen-re000530>

2026-04-02