

Parte esterna termostatico doccia incasso GRACE_MN007200

MODELLO **MN007200**

Parte esterna termostatico doccia incasso, senza rubinetto d'arresto, senza parte incasso, per art. ZA007221

FINITURE DISPONIBILI

-  **21** 21 Cromo
-  **2F** 2F Nichel Spazzolato
-  **2W** 2W Oro Spazzolato
-  **5H** 5H Dark Brass Brushed
-  **5L** 5L Black Titanium Spazzolato
-  **6T** 6T Cromo/Nero Opaco

CARATTERISTICHE

Installazione **Incasso**
 Parti Incasso necessarie **ZA007221**

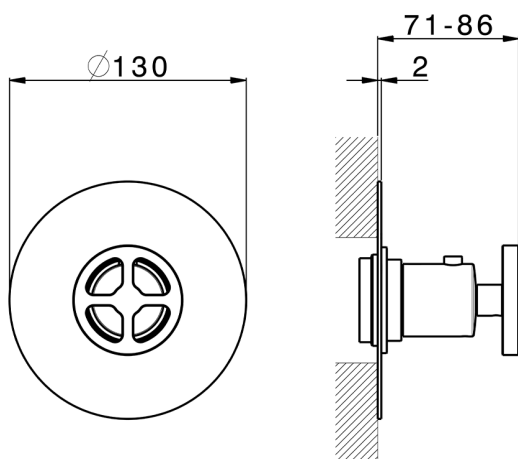
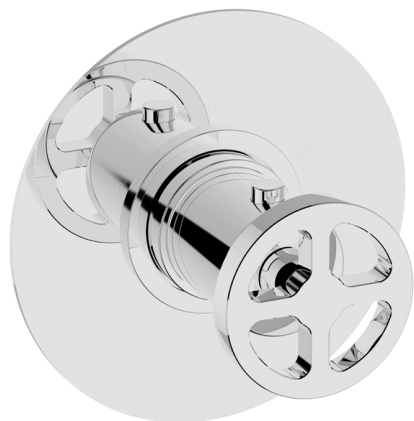

Termostatico

Il Termostatico Cisal è il tuo personale gestore dell'acqua che ti aiuta a gestire e controllare acqua ed energia senza sprechi.



Parte incasso termostatico 3/4" INCASSO_ZA007221

MODELLO **ZA007221**

Parte incasso termostatico 3/4", senza rubinetto d'arresto, senza parte esterna

FINITURE DISPONIBILI



CARATTERISTICHE

Ricambio Cartuccia **23.51A.HF**

Incasso **1**

Cartuccia Termostatica HF

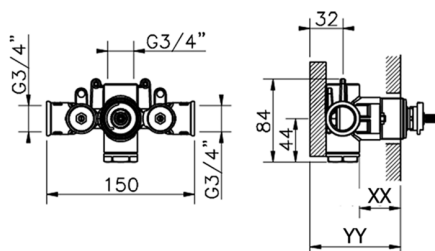

Piastra/Plate/Plaque/Platte/Placa
 2-3mm: XX 25-40 YY 76-91
 10mm: XX 16-31 YY 65-80



Termostatico

Il Termostatico Cisal è il tuo personale gestore dell'acqua che ti aiuta a gestire e controllare acqua ed energia senza sprechi.



2026-05-03