

Parte esterna monocomando doccia incasso SMOOTH X32_X3003000

MODELLO **X3003000**

Parte esterna monocomando doccia incasso, senza parte incasso, per art. ZA005300-ZA005301, con maniglia liscia, Inox AISI 316L

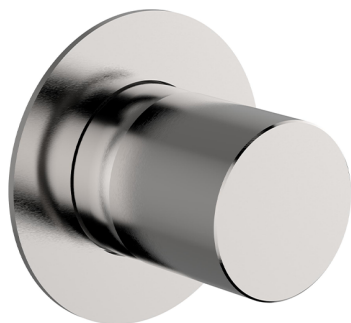

FINITURE DISPONIBILI

-  **D1** D1 Inox Spazzolato
-  **5H** 5H Dark Brass Brushed
-  **5L** 5L Black Titanium Spazzolato
-  **5N** 5N Oro Rosa Spazzolato

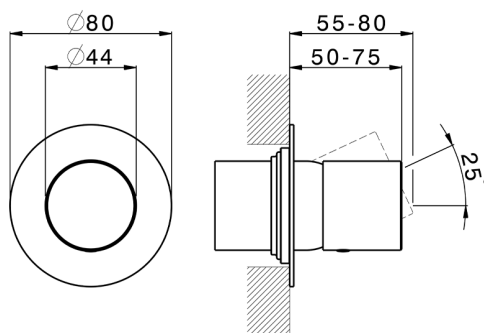

CARATTERISTICHE

Installazione **Incasso**
 Parti Incasso necessarie **ZA005301**
ZA005300



Parte esterna monocomando doccia incasso SMOOTH X32_X3003000

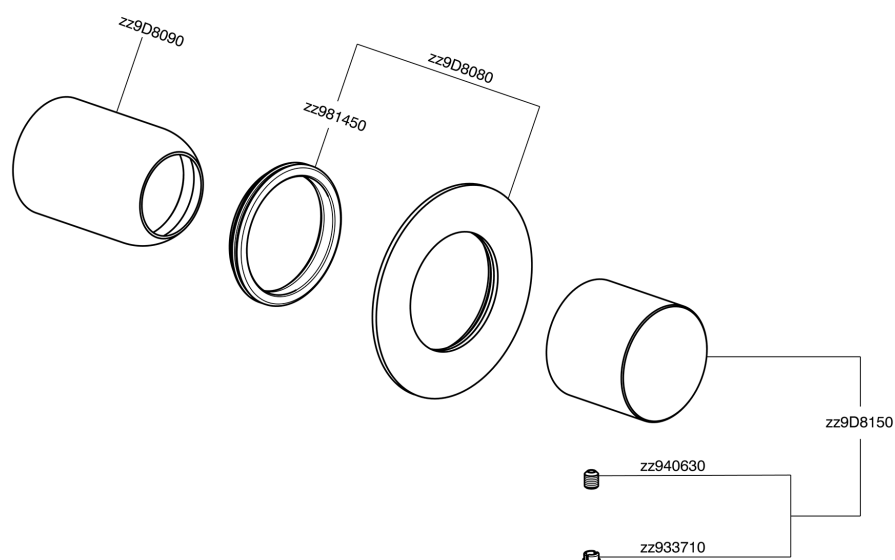

X3003000

<https://www.cisal.it/parte-esterna-monocomando-doccia-incasso-smooth-x32-x3003000>

Parte incasso monocomando doccia INCASSO_ZA005301

MODELLO **ZA005301**

Parte incasso monocomando doccia, doccia incasso 1/2", senza parte esterna, con silenziosi



FINITURE DISPONIBILI



04 04 Senza Finitura

CARATTERISTICHE

Ricambio Cartuccia **ZZ94035000**

Incasso **1**

Cartuccia Monocomando 35 mm



Piastra/Plate/Plaque/Platte/Placa

2-3mm: XX 27-47 YY 54-74

10mm: XX 16-40 YY 43-68



Parte incasso monocomando doccia INCASSO_ZA005300

MODELLO **ZA005300**

Parte incasso monocomando doccia, doccia incasso 1/2", senza parte esterna

FINITURE DISPONIBILI



04 04 Senza Finitura



CARATTERISTICHE

Ricambio Cartuccia **ZZ94035000**

Incasso **1**

Cartuccia Monocomando 35 mm



Piastra/Plate/Plaque/Platte/Placa
 2-3mm: XX 27-47 YY 54-74
 10mm: XX 16-40 YY 43-68



2026-04-08