







## Parte esterna termostatico doccia incasso 2 uscite ROADSTER ACCENT\_RA018100



MODELLO **RA018100**

Parte esterna termostatico doccia incasso 2 uscite, con deviaspout 2 uscite, senza parte incasso, per art. ZA018101

### FINITURE DISPONIBILI

-  **21** 21 Cromo
-  **2B** 2B Nichel Lucido
-  **2F** 2F Nichel Spazzolato
-  **2Q** 2Q Black Titanium
-  **40** 40 Nero Opaco
-  **4Q** 4Q Bianco Opaco

### CARATTERISTICHE

Installazione **Incasso**  
Parti Incasso necessarie **ZA018101**



### Termostatico

Il Termostatico Cisal è il tuo personale gestore dell'acqua che ti aiuta a gestire e controllare acqua ed energia senza sprechi.



## Parte incasso termostatico doccia 2 uscite INCASSO\_ZA018101

MODELLO **ZA018101**

Parte incasso termostatico doccia 2 uscite, con devia stop 2 uscite 1/2", senza parte esterna



FINITURE DISPONIBILI

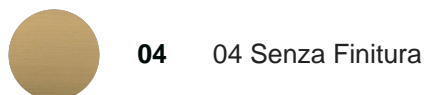

CARATTERISTICHE

Ricambio Cartuccia **24.04A.PP**

Incasso **1**

**Cartuccia Termostatica Plus P 8X20**

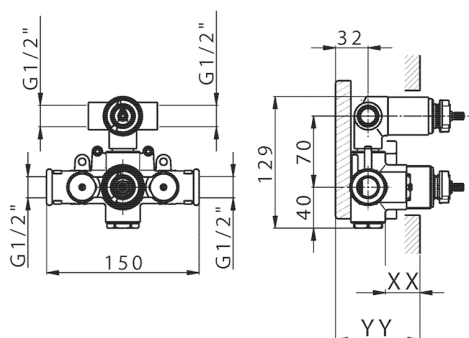

Piastra/Plate/Plaque/Platte/Placa

2-3mm: XX 25-40 YY 76-91

10 mm: XX 16-31 YY 65-80



### DeviaStop

La tecnologia Devia Stop di Cisal consente con un semplice movimento rotativo di gestire la portata dell'acqua e di scegliere la modalità d'erogazione (soffione, doccia a mano).



### Termostatico

Il Termostatico Cisal è il tuo personale gestore dell'acqua che ti aiuta a gestire e controllare acqua ed energia senza sprechi.



2026-05-09