

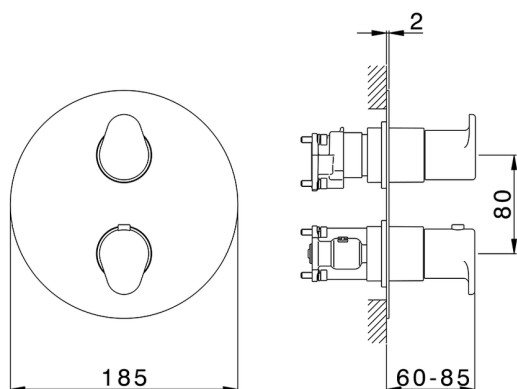

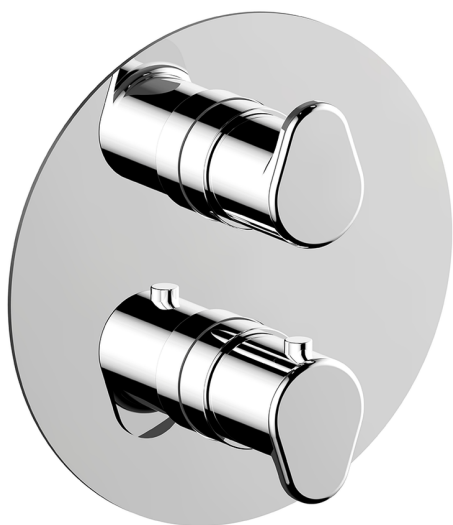



Completo Termostatico per One-Box ONE BOX_LV0BT030



MODELLO **LV0BT030**

Completo Termostatico per One-Box, con devia stop 1-2-3 uscite, profondità minima di installazione 67 mm, senza parte incasso, per art. ZA00B030-ZA00B031

FINITURE DISPONIBILI

-  **21** 21 Cromo
-  **2B** 2B Nichel Lucido
-  **2F** 2F Nichel Spazzolato
-  **40** 40 Nero Opaco
-  **4Q** 4Q Bianco Opaco

CARATTERISTICHE

Ricambio Cartuccia **24.04A.PP**
Cartuccia Termostatica Plus P 8X20
 Installazione **Incasso**
 Parti Incasso necessarie **ZA00B031**
ZA00B030



DeviaStop

La tecnologia Devia Stop di Cisal consente con un semplice movimento rotativo di gestire la portata dell'acqua e di scegliere la modalità d'erogazione (soffione, doccetta a mano).



Termostatico

Il Termostatico Cisal è il tuo personale gestore dell'acqua che ti aiuta a gestire e controllare acqua ed energia senza sprechi.



Completo Termostatico per One-Box ONE BOX_LV0BT030

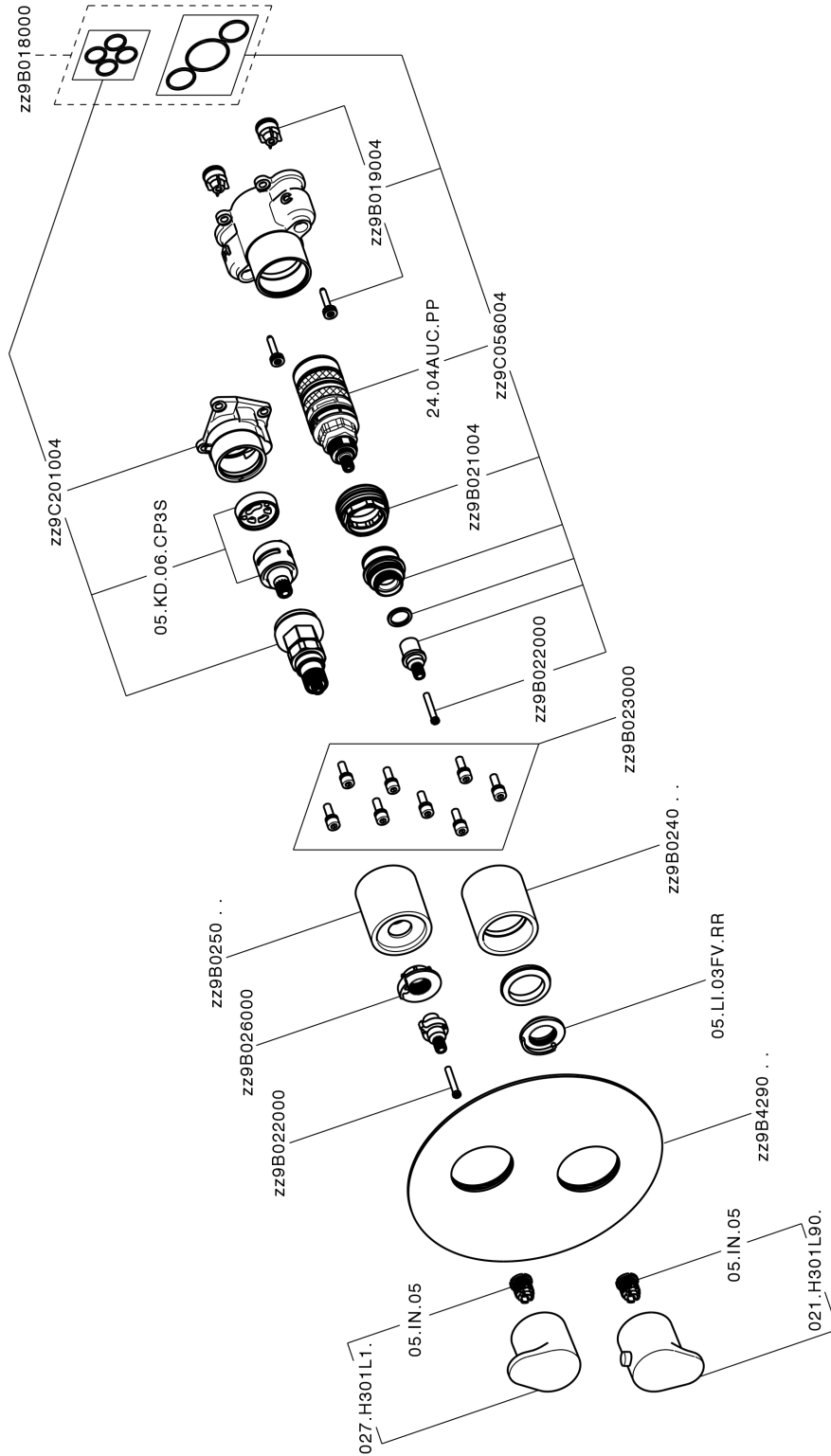

LV0BT030

<https://www.cisal.it/completo-termostatico-per-one-box-one-box-lv0bt030>

One-Box Universale per incasso ONE BOX_ZA00B031

MODELLO **ZA00B031**

One-Box Universale per incasso, per termostatico o monocomando 1, 2 o 3 uscite, senza parte esterna, con silenziosi, con guarnizione per sigillatura

FINITURE DISPONIBILI

 **04** 04 Senza Finitura

CARATTERISTICHE

Incasso **1**



Termostatico

Il Termostatico Cisal è il tuo personale gestore dell'acqua che ti aiuta a gestire e controllare acqua ed energia senza sprechi.



One-Box Universale per incasso ONE BOX_ZA00B030

MODELLO **ZA00B030**

One-Box Universale per incasso, per termostatico o monocomando 1, 2 o 3 uscite, senza parte esterna, senza silenziosi, con guarnizione per sigillatura

FINITURE DISPONIBILI

 **04** 04 Senza Finitura

CARATTERISTICHE

Incasso **1**



Termostatico

Il Termostatico Cisal è il tuo personale gestore dell'acqua che ti aiuta a gestire e controllare acqua ed energia senza sprechi.



2026-06-13