

Parte esterna lavabo a parete SMOOTH X32_X4013511

MODELLO **X4013511**

Parte esterna lavabo a parete, senza parte incasso, per art. ZA033510, con maniglie lisce, Inox AISI 316L

FINITURE DISPONIBILI

-  **D1** D1 Inox Spazzolato
-  **5H** 5H Dark Brass Brushed
-  **5L** 5L Black Titanium Spazzolato
-  **5N** 5N Oro Rosa Spazzolato

CARATTERISTICHE

Installazione **Incasso**
Parti Incasso necessarie **ZA033510**

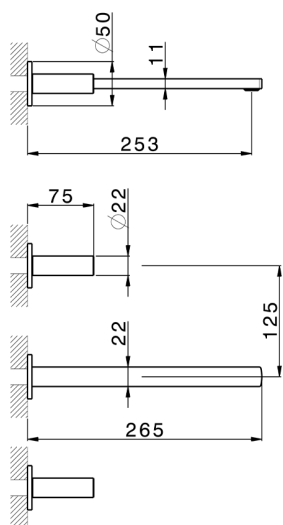

Parte esterna lavabo a parete SMOOTH X32_X4013511

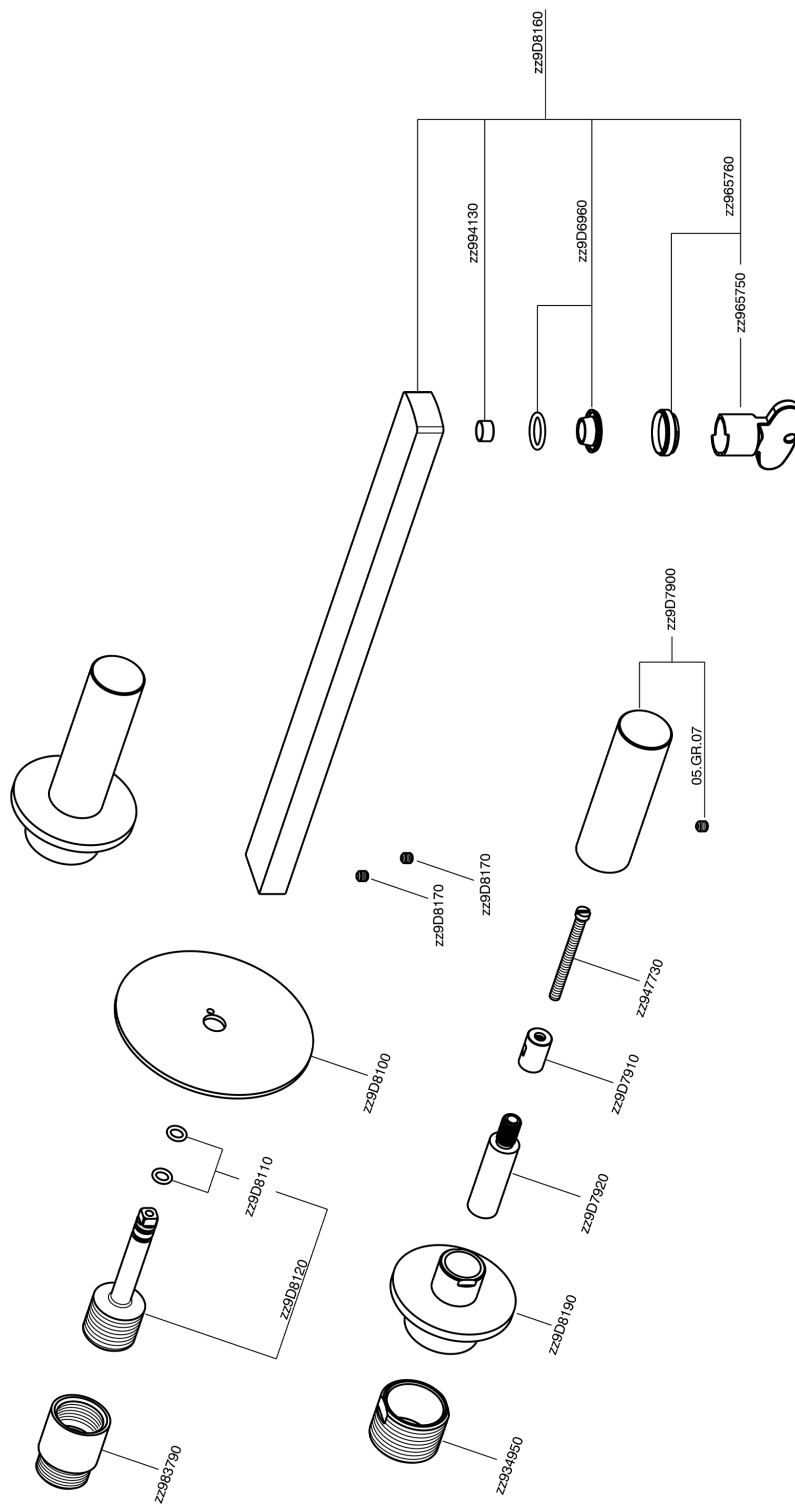

X4013511

<https://www.cisal.it/parte-esterna-lavabo-a-parete-smooth-x32-x4013511>

Parte incasso lavabo a parete INCASSO_ZA033510

MODELLO **ZA033510**

Parte incasso lavabo a parete, con due vitoni destri

FINITURE DISPONIBILI



CARATTERISTICHE

Incasso **1**

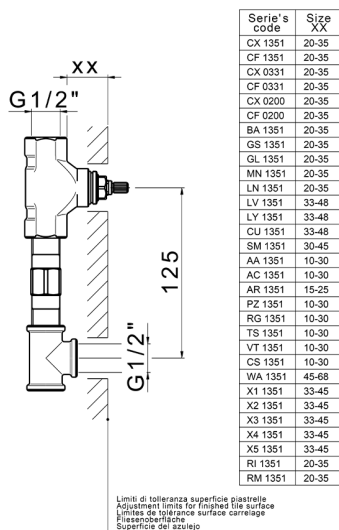

2026-05-16