

Parte esterna termostatico vasca incasso 2 uscite GRACE_GS019441

MODELLO **GS019441**

Parte esterna termostatico vasca incasso 2 uscite, con deviasop 2 uscite, doccetta monogetto D.22,5 mm in Ottone, flessibile liscio SUPREME 150 cm, senza parte incasso - per art.ZA019440

FINITURE DISPONIBILI

-  **21** 21 Cromo
-  **2F** 2F Nichel Spazzolato
-  **2W** 2W Oro Spazzolato
-  **5H** 5H Dark Brass Brushed
-  **5L** 5L Black Titanium Spazzolato
-  **6T** 6T Cromo/Nero Opaco

CARATTERISTICHE

Installazione **Incasso**
 Parti Incasso necessarie **ZA019440**

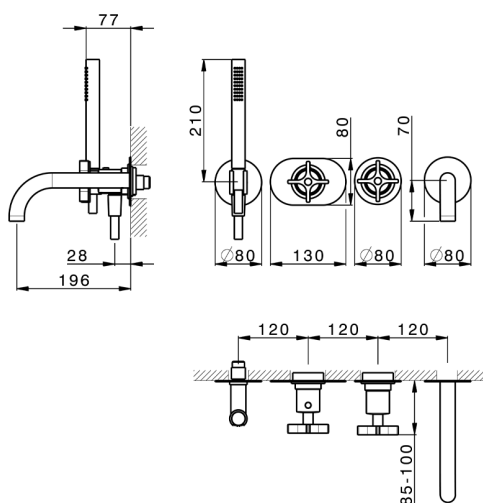

Termostatico

Il Termostatico Cisal è il tuo personale gestore dell'acqua che ti aiuta a gestire e controllare acqua ed energia senza sprechi.



Parte incasso termostatico vasca 2 uscite INCASSO_ZA019440

MODELLO **ZA019440**

Parte incasso termostatico vasca 2 uscite, senza parte esterna

FINITURE DISPONIBILI

 **04** 04 Senza Finitura

CARATTERISTICHE

Ricambio Cartuccia **24.04A.PP**

Incasso **1**

Cartuccia Termostatica Plus P 8X20

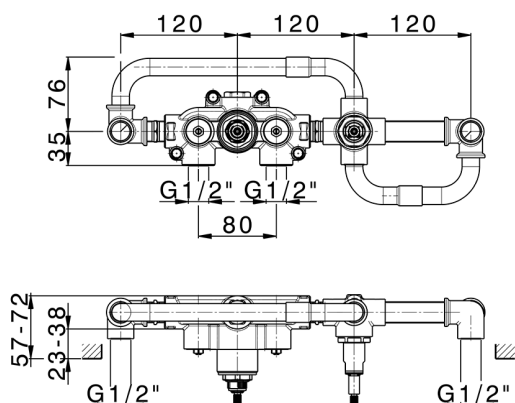

Termostatico

Il Termostatico Cisal è il tuo personale gestore dell'acqua che ti aiuta a gestire e controllare acqua ed energia senza sprechi.



2026-05-07