

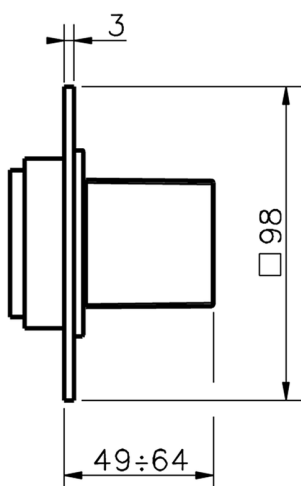





## Parte esterna rubinetto ROADSTER ACCENT\_RA003310

MODELLO **RA003310**

Parte esterna rubinetto, senza parte incasso, per art. ZA003330



### FINITURE DISPONIBILI

-  **21** 21 Cromo
-  **2B** 2B Nichel Lucido
-  **2F** 2F Nichel Spazzolato
-  **2Q** 2Q Black Titanium
-  **40** 40 Nero Opaco
-  **4Q** 4Q Bianco Opaco

### CARATTERISTICHE

Installazione **Incasso**  
 Parti Incasso necessarie **ZA003340**  
**ZA003330**



## Parte incasso rubinetto 1/2" INCASSO\_ZA003340

MODELLO **ZA003340**

Parte incasso rubinetto 1/2", apertura in senso antiorario



FINITURE DISPONIBILI

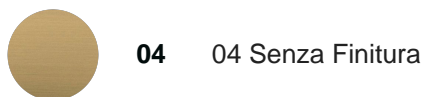

CARATTERISTICHE

Incasso **1**

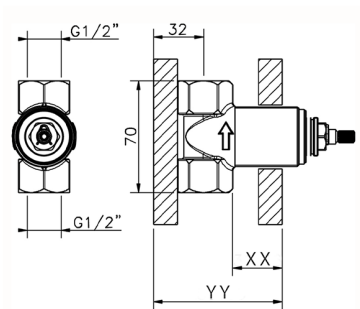

Piastra/Plate/Plaque/Platte/Placa  
 2-3mm: XX 31-46 YY 80-95  
 10mm: XX 25-40 YY 76-91



## Parte incasso rubinetto 3/4" INCASSO\_ZA003330

MODELLO **ZA003330**

Parte incasso rubinetto 3/4", apertura in senso antiorario



FINITURE DISPONIBILI



**04** 04 Senza Finitura

CARATTERISTICHE

Incasso **1**

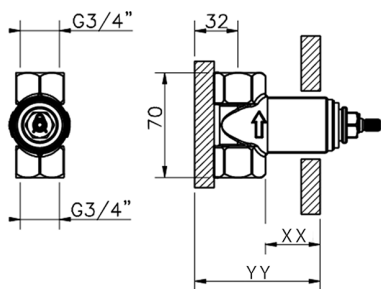

Piastra/Plate/Plaque/Platte/Placa

2-3mm: XX 31-46 YY 80-95

10mm: XX 25-40 YY 76-91



2026-06-21