

Bocca di erogazione COMPLEMENTI_ZA001253

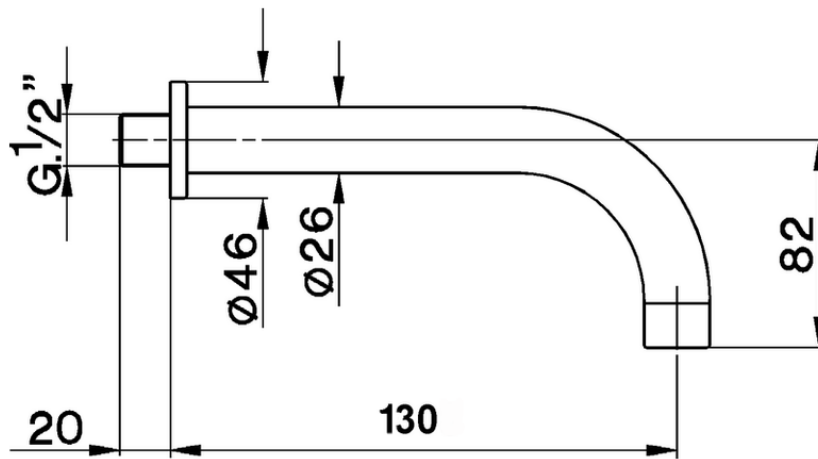

ZA001253

<https://www.cisal.it/bocca-di-erogazione-complementi-za001253>

2026-07-05