

Parte incasso termostatico 2 funzioni INCASSO_ZA01R200

MODELLO **ZA01R200**

Parte incasso termostatico 2 funzioni

FINITURE DISPONIBILI



04 04 Senza Finitura



CARATTERISTICHE

Ricambio Cartuccia **23.51A.HF**

Incasso **1**

Cartuccia Termostatica HF

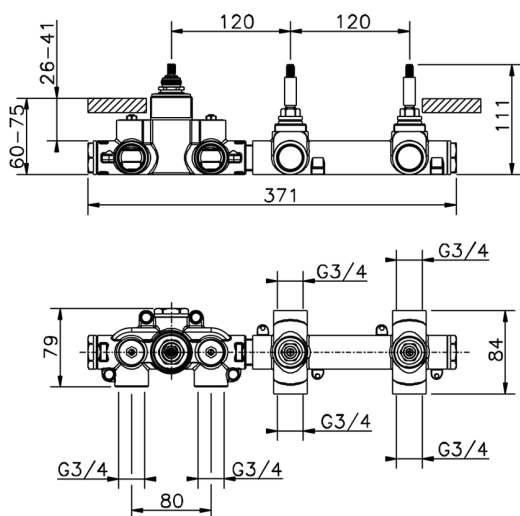

Termostatico

Il Termostatico Cisal è il tuo personale gestore dell'acqua che ti aiuta a gestire e controllare acqua ed energia senza sprechi.



2025-04-28