

## Parte esterna monocomando doccia incasso LESS MINIMAL\_LN003000C

MODELLO **LN003000C**

Parte esterna monocomando doccia incasso, senza parte incasso, per art. ZA005300-ZA0G1700

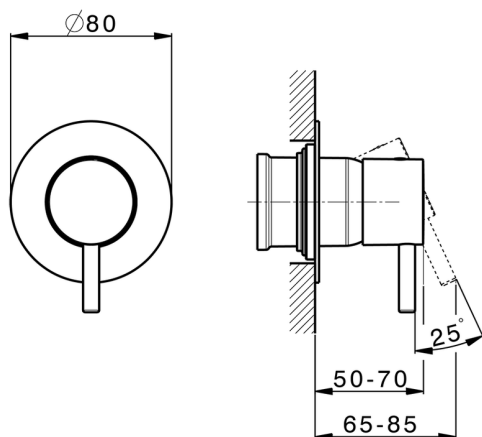

### FINITURE DISPONIBILI

- 
**21** 21 Cromo
- 
**2F** 2F Nichel Spazzolato
- 
**40** 40 Nero Opaco
- 
**4Q** 4Q Bianco Opaco
- 
**2W** 2W Oro Spazzolato
- 
**26** 26 Vecchio Rame
- 
**3W** 3W Brushed Black Titanium
- 
**43** 43 Salvia
- 
**44** 44 Graphite
- 
**45** 45 Argilla
- 
**46** 46 Metal Bronze
- 
**47** 47 Cemento

## CARATTERISTICHE

Installazione **Incasso**  
Parti Incasso necessarie **ZA0G1700**  
**ZA005301**  
**ZA005300**



## Parte incasso monocomando doccia INCASSO\_ZA005301

MODELLO **ZA005301**

Parte incasso monocomando doccia, doccia incasso 1/2", senza parte esterna, con silenziosi



FINITURE DISPONIBILI



**04** 04 Senza Finitura

CARATTERISTICHE

Ricambio Cartuccia **ZZ94035000**

Incasso **1**

**Cartuccia Monocomando 35 mm**



Piastra/Plate/Plaque/Platte/Placa  
 2-3mm: XX 27-47 YY 54-74  
 10mm: XX 16-40 YY 43-68



## Parte incasso monocomando doccia INCASSO\_ZA005300

MODELLO **ZA005300**

Parte incasso monocomando doccia, doccia incasso  
1/2", senza parte esterna



FINITURE DISPONIBILI



**04** 04 Senza Finitura

CARATTERISTICHE

Ricambio Cartuccia **ZZ94035000**

Incasso **1**

**Cartuccia Monocomando 35 mm**



Piastra/Plate/Plaque/Platte/Placa  
2-3mm: XX 27-47 YY 54-74  
10mm: XX 16-40 YY 43-68



2026-06-21