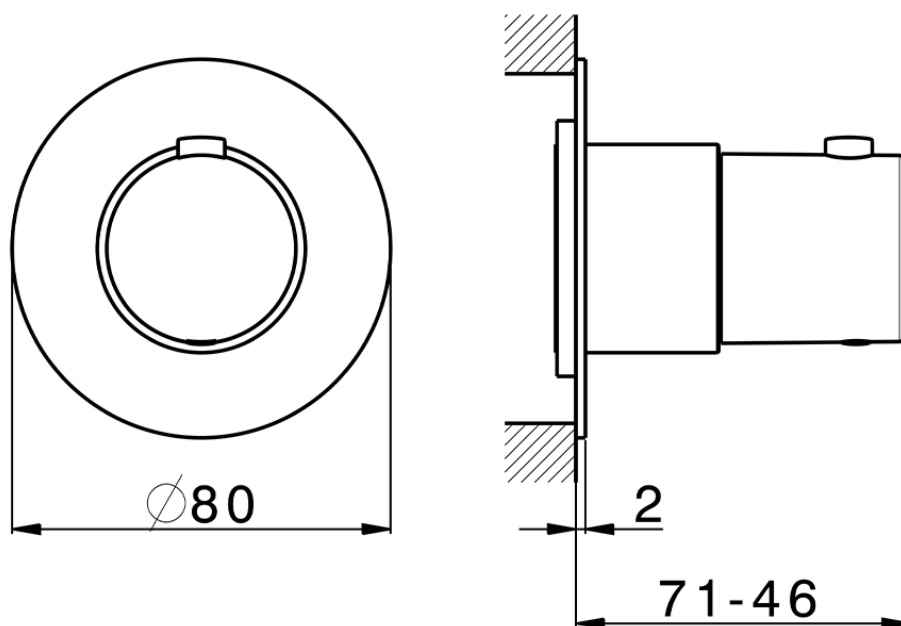

Parte esterna termostatico incasso PUSH&SHOWER_PS1G1010

PS1G1010

<https://www.cisal.it/parte-esterna-termostatico-incasso-pushshower-ps1g1010>

2026-04-20