

Parte esterna termo doccia incasso 3 funzioni NUOVA LESS_LN01R300

MODELLO **LN01R300**

Parte esterna termo doccia incasso 3 funzioni, per art.ZA01R300

FINITURE DISPONIBILI

-  **21** 21 Cromo
-  **2F** 2F Nichel Spazzolato
-  **40** 40 Nero Opaco
-  **4Q** 4Q Bianco Opaco



CARATTERISTICHE

Installazione **Incasso**
Parti Incasso necessarie **ZA01R300**



Termostatico

Il Termostatico Cisal è il tuo personale gestore dell'acqua che ti aiuta a gestire e controllare acqua ed energia senza sprechi.



Parte incasso termostatico 3 funzioni INCASSO_ZA01R300

MODELLO **ZA01R300**

Parte incasso termostatico 3 funzioni

FINITURE DISPONIBILI



04 04 Senza Finitura

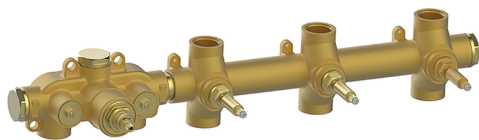

CARATTERISTICHE

Ricambio Cartuccia **23.51A.HF**

Incasso **1**

Cartuccia Termostatica HF

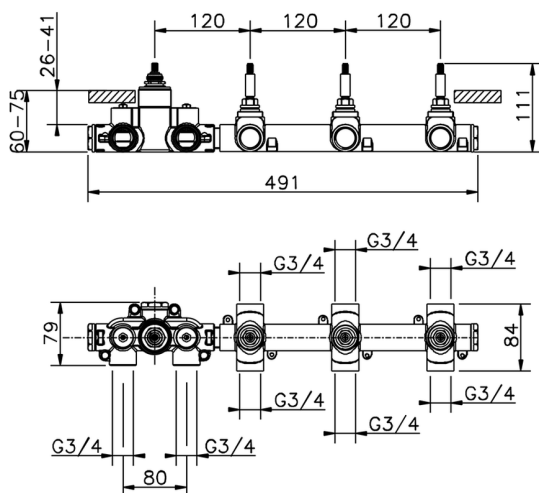

Termostatico

Il Termostatico Cisal è il tuo personale gestore dell'acqua che ti aiuta a gestire e controllare acqua ed energia senza sprechi.



2026-04-27