

Parte esterna monocomando doccia incasso LINEAVIVA_LV003000C

MODELLO **LV003000C**

Parte esterna monocomando doccia incasso, senza parte incasso, per art. ZA005300-ZA0G1700

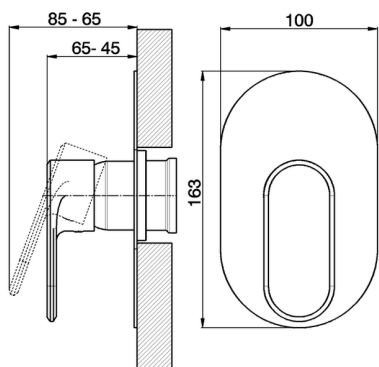

FINITURE DISPONIBILI

-  **21** 21 Cromo
-  **2F** 2F Nichel Spazzolato
-  **40** 40 Nero Opaco
-  **4Q** 4Q Bianco Opaco
-  **2W** 2W Oro Spazzolato
-  **26** 26 Vecchio Rame
-  **3W** 3W Brushed Black Titanium
-  **43** 43 Salvia
-  **44** 44 Graphite
-  **45** 45 Argilla
-  **46** 46 Metal Bronze
-  **47** 47 Cemento

CARATTERISTICHE

Installazione **Incasso**
Parti Incasso necessarie **ZA0G1700**
ZA005300



Parte esterna monocomando doccia incasso LINEAVIVA_LV003000C

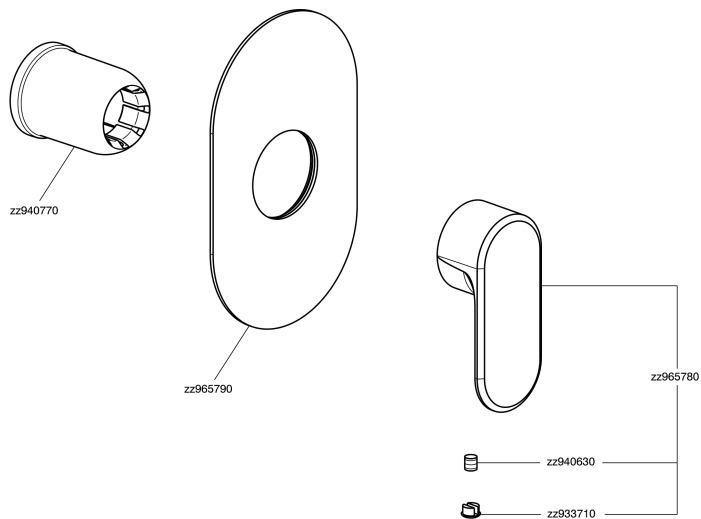

LV003000C

<https://www.cisal.it/parte-esterna-monocomando-doccia-incasso-lineaviva-lv003000c>

Parte incasso monocomando doccia INCASSO_ZA005300



MODELLO **ZA005300**

Parte incasso monocomando doccia, doccia incasso 1/2", senza parte esterna

FINITURE DISPONIBILI



04 04 Senza Finitura

CARATTERISTICHE

Ricambio Cartuccia **ZZ94035000**

Incasso **1**

Cartuccia Monocomando 35 mm



Piastra/Plate/Plaque/Platte/Placa
 2-3mm: XX 27-47 YY 54-74
 10mm: XX 16-40 YY 43-68



2026-05-02