

Parte esterna monocomando doccia incasso LINEAVIVA_LV003000C

MODELLO **LV003000C**

Parte esterna monocomando doccia incasso, senza parte incasso, per art. ZA005300-ZA0G1700



FINITURE DISPONIBILI

- 
21 21 Cromo
- 
2F 2F Nichel Spazzolato
- 
40 40 Nero Opaco
- 
4Q 4Q Bianco Opaco
- 
2W 2W Oro Spazzolato
- 
26 26 Vecchio Rame
- 
3W 3W Brushed Black Titanium
- 
43 43 Salvia
- 
44 44 Graphite
- 
45 45 Argilla
- 
46 46 Metal Bronze
- 
47 47 Cemento



CARATTERISTICHE

Installazione **Incasso**
Parti Incasso necessarie **ZA0G1700**
ZA005300



Parte esterna monocomando doccia incasso LINEAVIVA_LV003000C

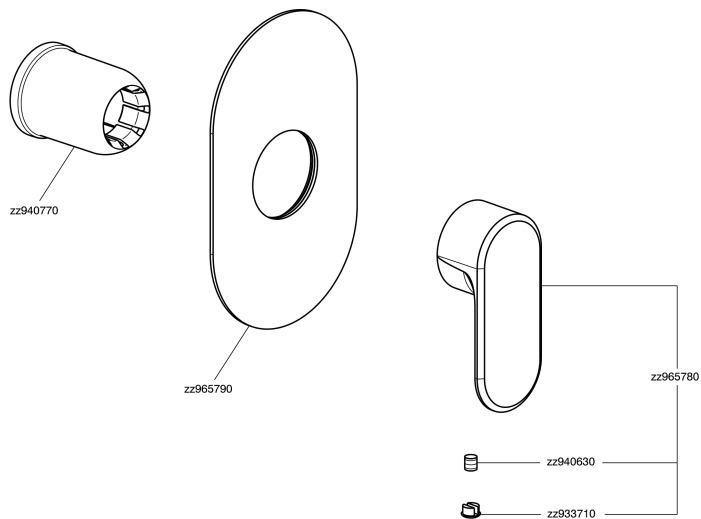

LV003000C

<https://www.cisal.it/parte-esterna-monocomando-doccia-incasso-lineaviva-lv003000c>

Parte incasso monocomando doccia INCASSO_ZA005300

MODELLO **ZA005300**

Parte incasso monocomando doccia, doccia incasso
1/2", senza parte esterna

FINITURE DISPONIBILI



04 04 Senza Finitura



CARATTERISTICHE

Ricambio Cartuccia **ZZ94035000**

Incasso **1**

Cartuccia Monocomando 35 mm

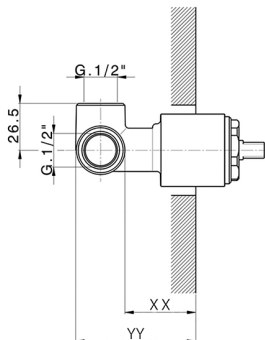

Piastra/Plate/Plaque/Platte/Placa

2-3mm: XX 27-47 YY 54-74

10mm: XX 16-40 YY 43-68



2026-06-19