

Parte esterna termostatico doccia incasso 1 uscita HI-RISE_RI009300

RI009300

<https://www.cisal.it/parte-esterna-termostatico-doccia-incasso-1-uscita-hi-rise-ri009300>

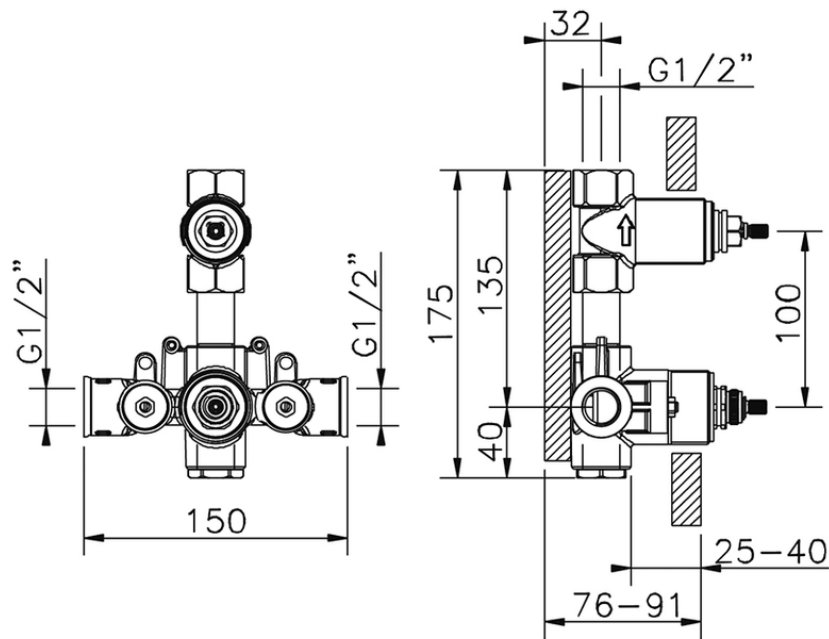

ZA009301

<https://www.cisal.it/parte-incasso-termostatico-doccia-1-uscita-incasso-za009301>

2026-05-15