

IT - ISTRUZIONI DI MONTAGGIO
EN - ASSEMBLY INSTRUCTIONS
DE - MONTAGEANLEITUNG
FR - INSTRUCTIONS DE MONTAGE

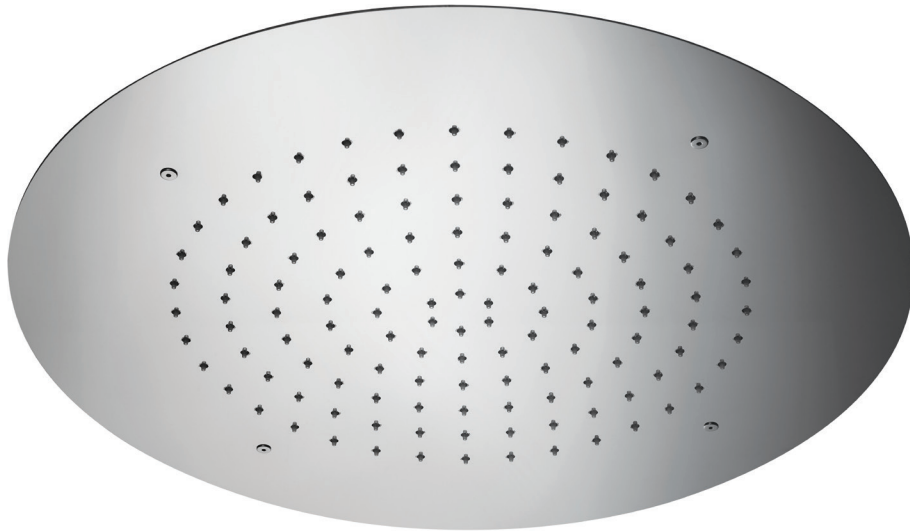

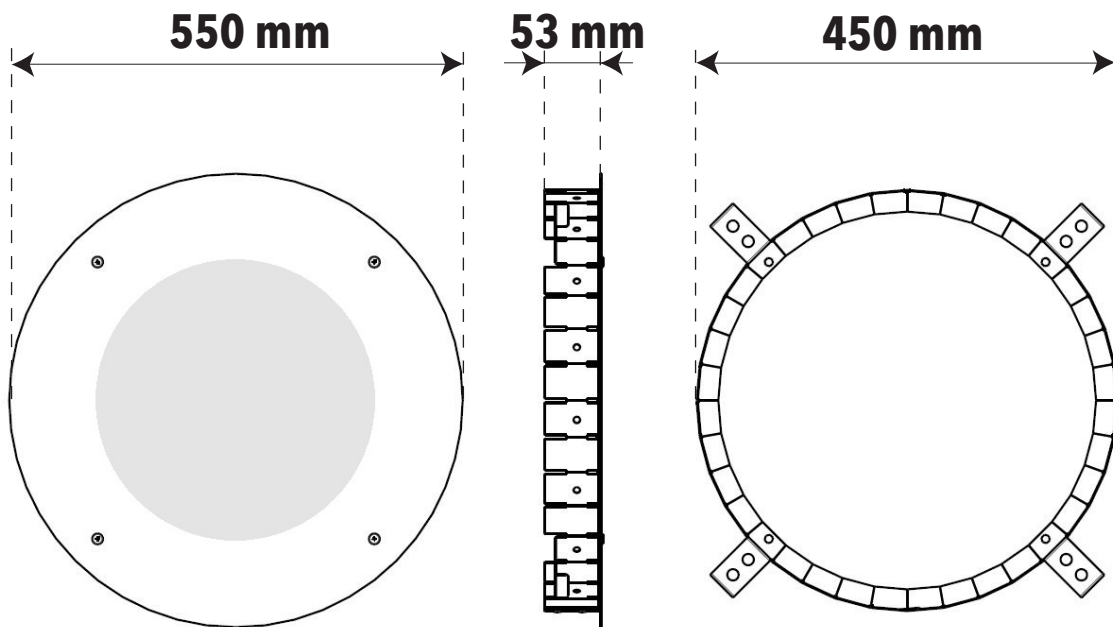

IT-Dimensioni sede telaio
EN-Hole cut size
DE-Rahmensitz Abmessungen
FR-Dimensions du siège du cadre

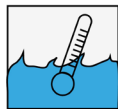
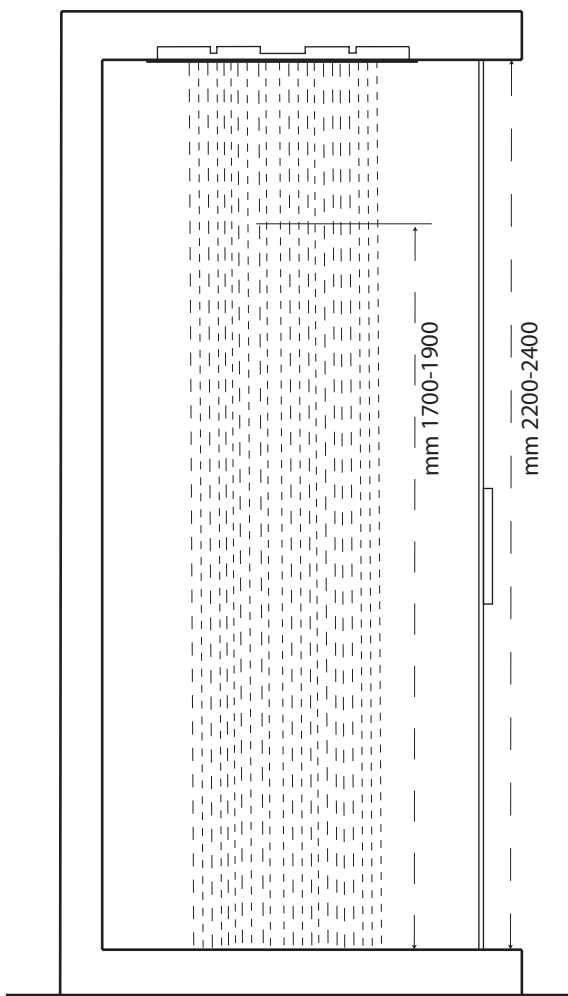

MAX 70°C
BEST 38/40°C



MIN 1 Bar
MAX 5 Bar
BEST 3 Bar

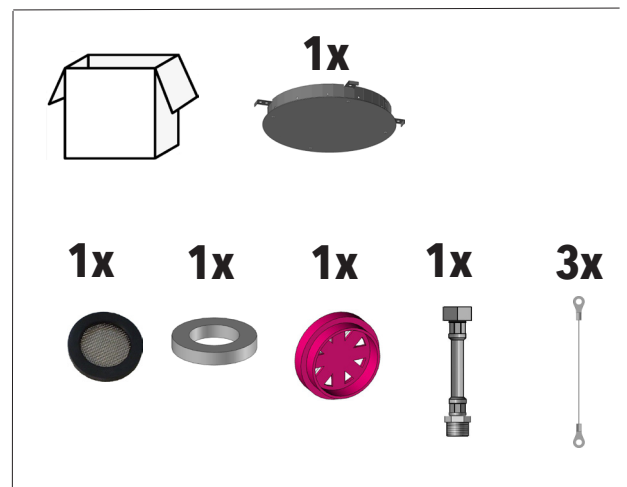
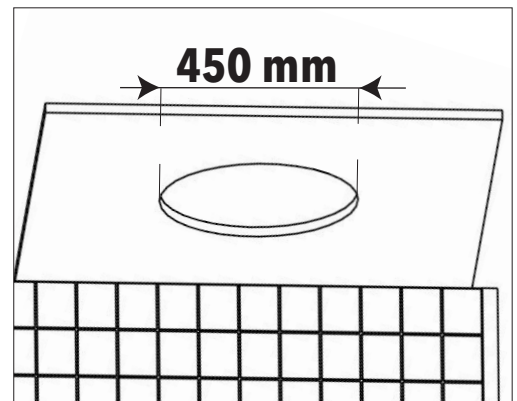

IT - L'apparechio deve essere installato da personale abilitato ai sensi e per l'effetto delle leggi in vigore.

EN - According to the law, all installation and maintenance operations require a qualified person.

DE - Das Gerät muss von qualifiziertem Personal gemäß den geltenden Gesetzen installiert werden.

FR - L'appareil doit être installé par du personnel qualifié conformément et pour l'effet des lois en vigueur.

1

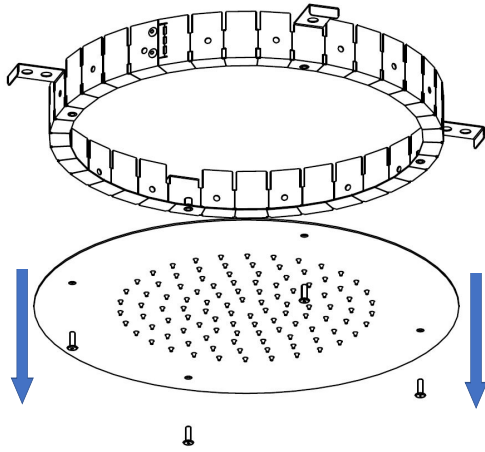

Ch. 2 mm



3

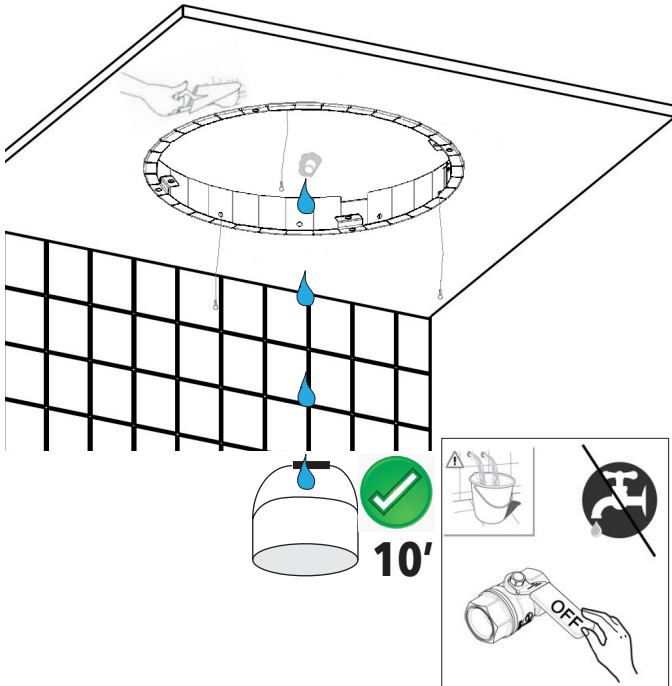

5

300 mm
IT-Pioggia
EN-Rain
DE-Regen
FR-Pluie

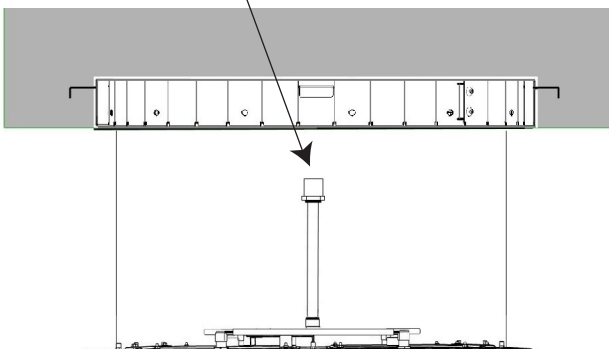

2

IT-Usare per il fissaggio
EN-Use clamps for fixing
DE-Zum Befestigen verwenden
FR-Utiliser pour la fixation

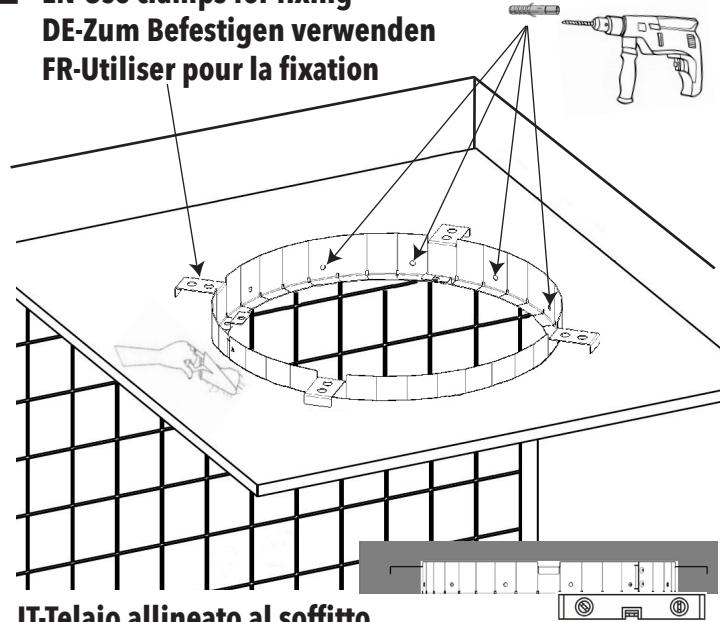

IT-Telaio allineato al soffitto
EN-Align frame to ceiling
DE-Rahmen aus der Decke ausgerichtet
FR-Installez le cadre bien aligné au plafond

4

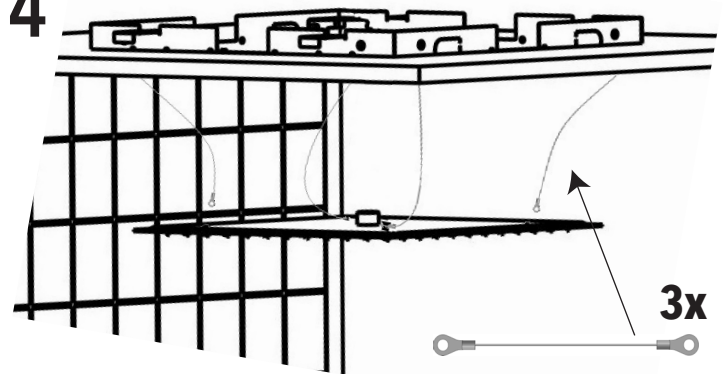

 IT-Cavo di sicurezza (se fornito)
EN-Safety cable (if supplied)
DE-Sicherheitskabel (sofern vorhanden)
FR-Câble de sécurité (si fourni)

6

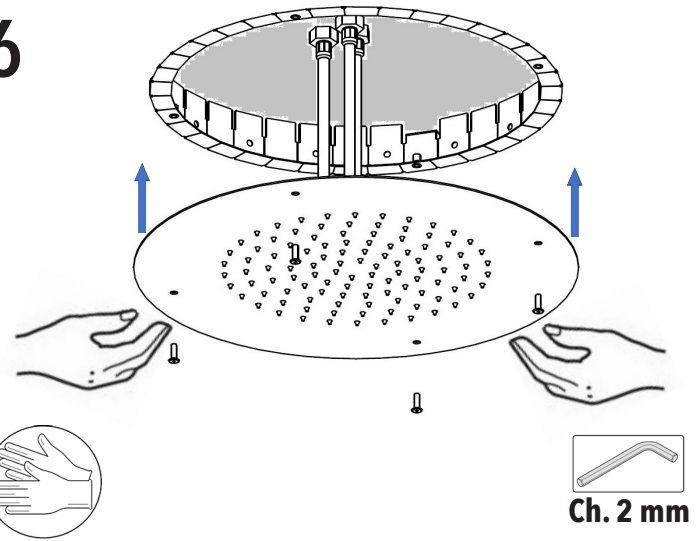

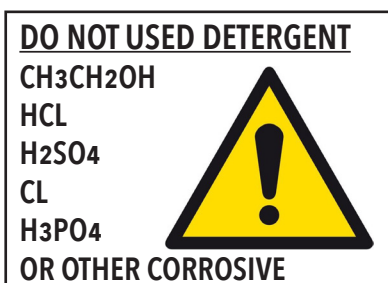

IT - LA GARANZIA DEL PRODOTTO NON COPRE

L'utilizzo improprio.
L'errata predisposizione dell'impianto idraulico.
Danni causati da depositi di calcare o altre impurità.
Detergenti non adatti.

EN - NOT COVERED BY PRODUCT CARE

Not correct use.
Incorrect setup of the hydraulic system.
Water impurities or limestone deposits.
Improper detergents.

DE - DIE PRODUKTGARANTIE GILT NICHT

Die falsche Verwendung
Die falsche Anordnung des Hydrauliksystems.
Schäden durch Kalkablagerungen oder andere Verunreinigungen.
Ungeeignete Reiniger.

FR - LA GARANTIE DU PRODUIT NE COUVRE PAS

Utilisation incorrecte.
La mauvaise disposition du système hydraulique.
Dommages causés par des dépôts de calcaire ou d'autres impuretés.
Nettoyants inappropriés.

IT - DUE ANNI DI GARANZIA DEL PRODOTTO

Contro i difetti o vizi di fabbricazione.

EN - TWO-YEAR PRODUCT CARE

Against defects of fabrication.

DE - ZWEI JAHRE LANG PRODUKTGARANTIE

Gegen Mängel oder Herstellungsfehler

FR - GARANTIE DE PRODUITS DE DEUX ANSO

Contre les défauts de fabrication.

IT - ATTENZIONE: Si declina ogni responsabilità relativa ad eventuali inesattezze contenute in queste istruzioni dovute ad errori di trascrizione.

EN - WARNING: We decline all responsibility for eventual inaccuracy contained in the instructions due to transcript errors.

DE - ACHTUNG: Wir lehnen jede Verantwortung für Ungenauigkeiten in diesen Anleitung aufgrund von Transkriptionsfehlern ab.

FR - ATTENTION: Nous déclinons toute responsabilité pour toute inexactitude contenue dans ces instructions en raison d'erreurs de transcription.